

Mathematics

Kagamitan ng Mag-aaral

Waray

Ang kagamitan sa pagtuturong ito ay magkatuwang na inihanda at sinuri ng mga edukador mula sa mga publiko at pribadong paaralan, kolehiyo, at / o unibersidad. Hinihikayat namin ang mga guro at ibang nasa larangan ng edukasyon na mag-email ng kanilang puna at mungkahi sa Kagawaran ng Edukasyon sa action@deped.gov.ph.

Mahalaga sa amin ang inyong mga puna at mungkahi.

**Mathematics – Unang Baitang
Kagamitan ng Mag-aaral sa Waray
Unang Edisyon, 2013
ISBN: 978-971-9981-62-6**

Paunawa hinggil sa karapatang-sipi. Isinasaad ng Seksiyon 176 ng Batas Pambansa Bilang 8293: Hindi maaaring magkaroon ng karapatang-sipi sa ano mang akda ng Pamahalaan ng Pilipinas. Gayon pa man, kailangan muna ang pahintulot ng pamahalaan o tanggapan kung saan ginawa ang isang akda upang magamit sa pagkakakitaan ang nasabing akda. Kabilang sa mga maaaring gawin ng nasabing ahensiya o tanggapan ay ang patawan ng bayad na *royalty* bilang kondisyon.

Ang mga akda / materyales (mga kuwento, seleksiyon, tula, awit, larawan, ngalan ng produkto o *brand names*, tatak o *trademarks*, atbp.) na ginamit sa aklat na ito ay sa nagtataglay ng karapatang-ari ng mga iyon. Pinagsikapang mahanap at mahingi ang pahintulot ng mga may karapatang-ari upang magamit ang mga akdang ito. Hindi inaangkin ni kinakatawan ng mga tagapaglathala (*publisher*) at may-akda ang karapatang-aring iyon.

Inilathala ng Kagawaran ng Edukasyon
Kalihim: Br. Armin A. Luistro FSC
Pangalawang Kalihim: Dr. Yolanda S. Quijano
Kawaksing Kalihim: Dr. Elena R. Ruiz

Mga Bumuo ng Kagamitan ng Mag-aaral

Convenor: Ian June Garces, Ph.D.

Consultant at Koordinator: Soledad A. Ulep, Ph.D.

Mga Manunulat: Soledad A. Ulep, Ph.D., Lydia M. Landrito, Edna G. Callanta, Allan M. Canonigo, Dana M. Ong, Guillermo P. Bautista, Jr., Erlina R. Ronda, Teresita R. Mañalac, Gladys Nivera, at Shirley Remoto

Mga Kontribyutor: Avelina Salvador, Remyllinda Soriano, Maricar D. Agao, Maricar Alamon, Emerenciana T. Angeles, Felipa Bassig, Nely Baylon, Ofelia Chingcuanco, Irene R. Chua, John Antonio Daganta, Mary Jean dela Cruz, Robecil O. Endozo, Rosalinda Formeloza, Lourdes Hulipas, Juvylennie Nardo, Michelle S. Silva, at Ma. Corazon Silvestre

Mga Tagasuri ng Nilalaman: Soledad A. Ulep, Ph.D., Lydia M. Landrito, Edna G. Callanta, Rogelio O. Doñes, Ph.D., at Robesa R. Hilario

Mga Tagasuri ng Wika: Jose Evie G. Duclay, Jomar I. Cañega, at Ma. Victoria C. Casoy

Mga Tagasalin: Gretel Laura M. Cadiiong, Virgilia D. Dableo, Rosemarie M. Guino, Ramira R. Tayoni, Ronel R. Anasarias, Mercedita S. Garcia, at Sylvia D. Villanueva

Mga Gumuhit ng Larawan: Erich D. Garcia, Eric C. de Guia, Fermin M. Fabella, Deo R. Moreno, Amphy B. Ampong, Jayson R. Gaduena, Lemuel P. Valle, Jr., Bienvenido E. Saldua, at Jayson O. Villena

Mga Naglayout: Joselito B. Asi, Aro R. Rara, at John Rey T. Roco

Encoder: Jayson R. Gaduena

Inilimbag sa Pilipinas ng _____

Department of Education-Instructional Materials Council Secretariat (DepEd-IMCS)

Office Address: 2nd Floor Dorm G, PSC Complex, Meralco Avenue
Pasig City, Philippines 1600

Telefax: (02) 634-1054, 634-1072

E-mail Address: imcsetd@yahoo.com

LISTAHAN HAN PAG-ARADMAN

YUNIT 1

Ulohan	Paypay
Usa, Duha, Tulo	1
Upat, Lima, Unom	8
Pito, Wala, Siyam	15
Sero	22
Napulo	26
Onse ngadto Baynte	32
Baynte-Uno ngadto Singkuwenta	39
Singkuwenta Ngadto Usa ka Gatos	48
Sobra hin Usa	65
Iban hin Usa	68
“Guruguti ngan Darudamo”	72
Pareho Kadamo Han”	77
Pagsusunod-sunod Tikang ha Gutiay Tikadako o Tikang ha Dako Tiaagutiay nga Numero han mga Butang	81
Pagtanding hin mga Numero Kutob Usa Ka Gatos Gamit an mga Simbolo	86
Laktaw nga Pag-ihap hin Tag 2	95
Laktaw nga Pag-ihap hin Tag 5	98
Laktaw nga Pag-ihap hin Tag 10	103
Pagbungkag ngan Pagtig-ub Hin mga Numero	109
Tag-usa ngan Tagnapulo	113

YUNIT 1

Usa, Duha, Tulo

Pagpahinumdom:

	
	1
	usa

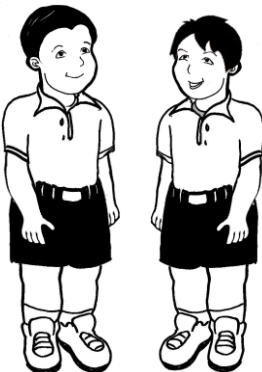
	
	2
	duha

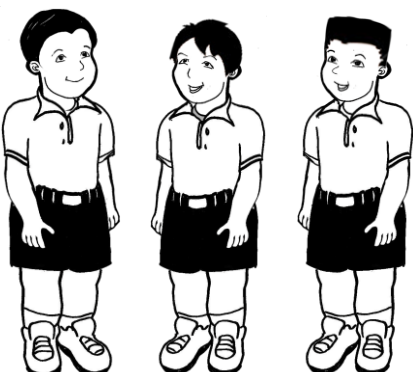
	
	3
	tulo

<p>An duha, in usa nga sobra hin usa.</p>	
<p>An tulo, in usa nga sobra hin duha.</p>	
<p>An usa, In duha iban hin usa</p>	
<p>An duha, In tulo iban hin usa.</p>	

Buruhaton 1.1: Igsiring an numero ngan kopyaha an simbolo ngan pulong ha imo papel.

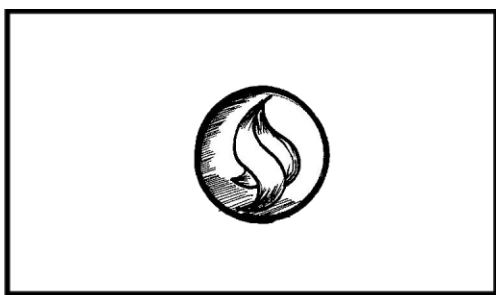

usa usa

usa

usa

usa

usa

usa

usa

usa

usa

usa

usa

usa

Buruhaton 1.2: Igsiring an numero ngan kopyaha an simbolo ngan pulong ha imo papel.

The handwriting practice sheet consists of the following elements:

- A rectangular box containing two circular symbols, each with a stylized, curved shape inside.
- Two rows of tracing exercises on lined paper. Each row contains a solid 'duna' and a dotted 'duna' for tracing. Below each 'duna' is a solid '2' and a dotted '2' for tracing. A vertical dashed line is positioned to the left of the '2' to indicate the starting point and direction of the stroke.
- Two more rows of tracing exercises on lined paper. Each row contains a solid 'duna' and a dotted 'duna' for tracing. Below each 'duna' is a solid '2' and a dotted '2' for tracing. A vertical dashed line is positioned to the left of the '2' to indicate the starting point and direction of the stroke.
- A final row of tracing exercises on lined paper containing three dotted 'duna' words for tracing.

Buruhaton 1.3: Igsiring an numero ngan kopyaha an simbolo ngan pulong ha imo papel.

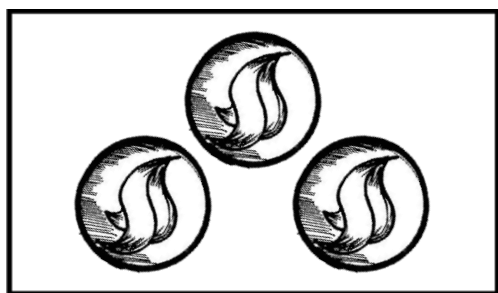

tulo tulo
3 3

tulo tulo
3 3

tulo tulo
3 3

tulo 3 tulo 3
3 tulo 3 tulo





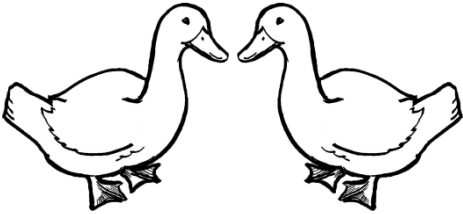
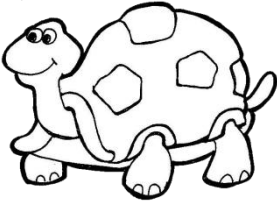
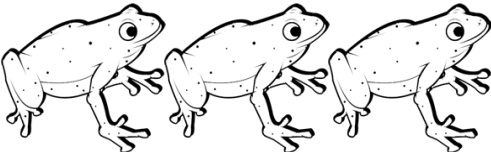
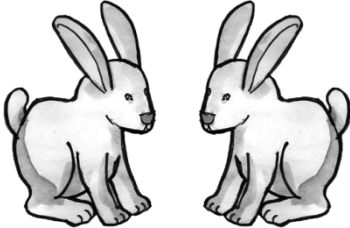
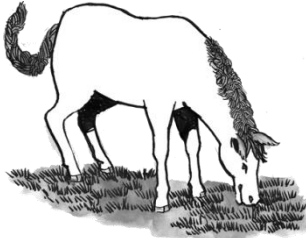
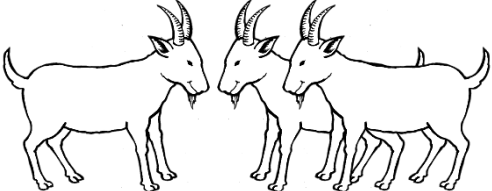

3 3 3

tulo tulo tulo

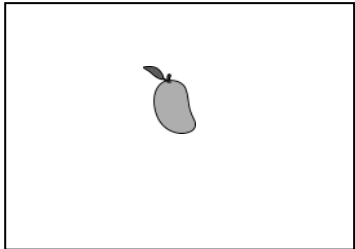
Buruhaton 2 – Ihapa kun pipira nga hayop an ada ha kada grupo. Igsurat ha imo papel an ngaran ngan simbolo han numero.

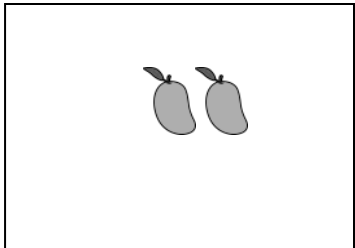
1. 	2. 
3. 	4. 
5. 	6. 

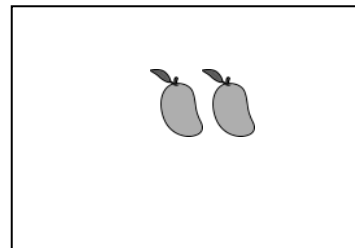
Buruhaton nga Pag-aradman ha Balay: Ihapa kun pipira nga mangga an ada kada grupo. Igsurat an kadamo han mangga 🍌 ha imo papel ha pulong ngan simbolo. Pagdrowing hin grupo hin 🍌 ha pagpakita han sobra hin usa o kulang hin usa.

1. 	Igpakita an sobra hin usa. 
2. 	Igpakita an kulang hin usa. 
3. 	Igpakita an sobra hin usa. 

Upat, Lima, Unom

Pagpahinumdom:

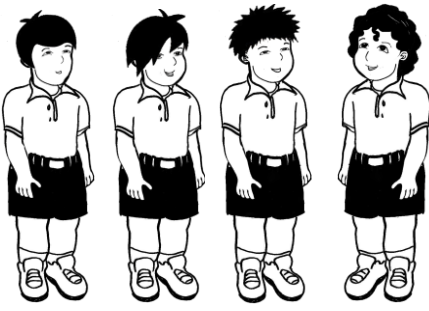
	<table border="1"><tr><td data-bbox="746 401 1313 549"></td></tr><tr><td data-bbox="746 549 1313 824">4 upat</td></tr></table>		4 upat
4 upat			

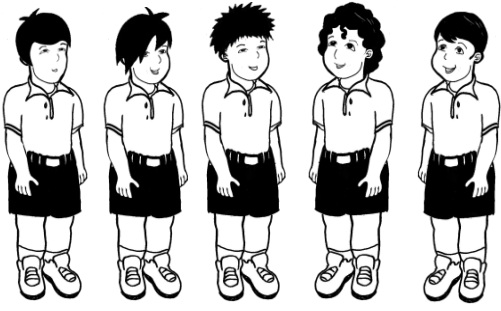
	<table border="1"><tr><td data-bbox="746 874 1313 1025"></td></tr><tr><td data-bbox="746 1025 1313 1299">5 lima</td></tr></table>		5 lima
5 lima			

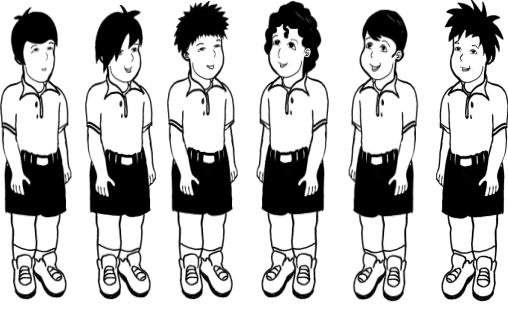
	<table border="1"><tr><td data-bbox="746 1348 1313 1502"></td></tr><tr><td data-bbox="746 1502 1313 1771">6 unom</td></tr></table>		6 unom
6 unom			

An lima,
in usa nga sobra hin
upat.

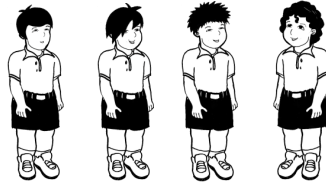
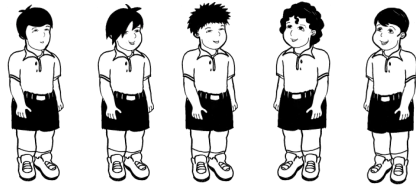

An unom,
in usa nga sobra hin
lima.

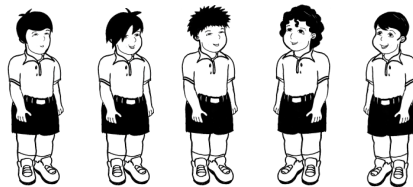

An upat,
in lima iban hin usa.

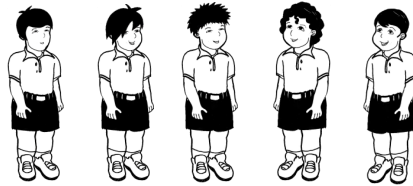
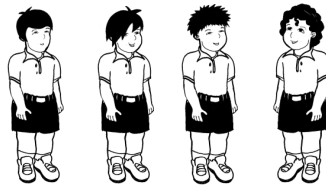

An lima,
in unom iban hin usa.

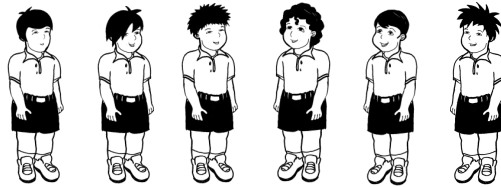
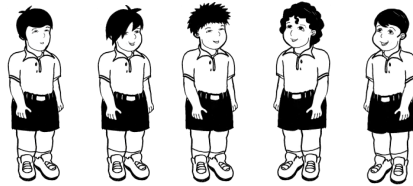

Buruhaton 1.1: Igsiring an numero ngan kopyaha an simbolo ngan pulong ha imo papel.

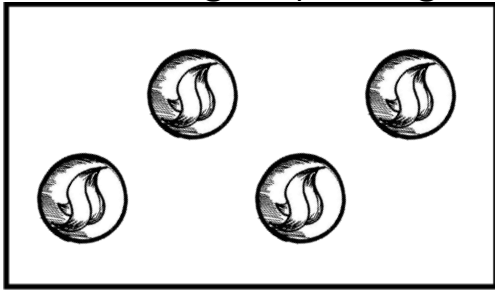

upa
4

upa
4

upa
4

upa
4

upa
4

upa 4
4 upa

upa 4
4 upa

upa
4

upa
4

Buruhaton 1.2: Igsiring an numero ngan kopyaha an simbolo ngan pulong ha imo papel.

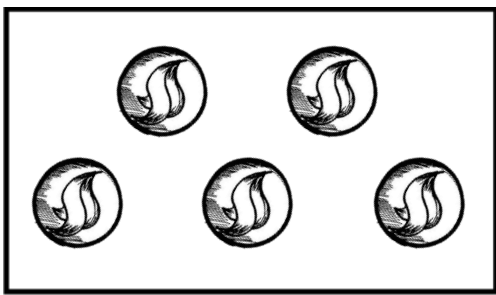
	lima
	5
lima	lima
5	5
lima	lima
5	5
lima 5	lima 5
5 lima	5 lima
5	5
lima	lima

Buruhaton 1.3: Igsiring an numero ngan kopyaha an simbolo ngan pulong ha imo papel.

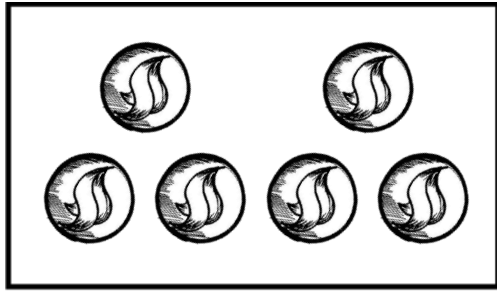

unom
6



unom unom
6 6

unom unom
6 6





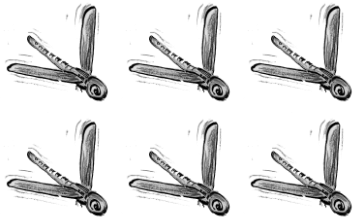
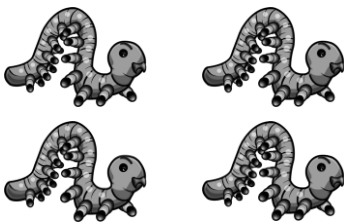
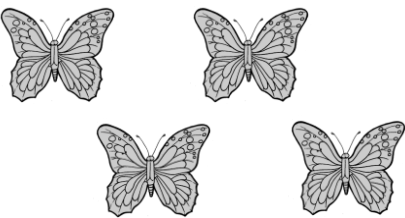

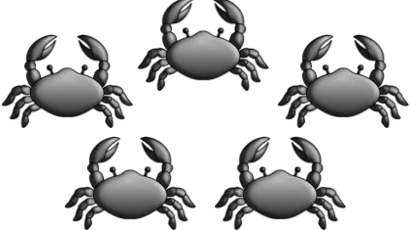
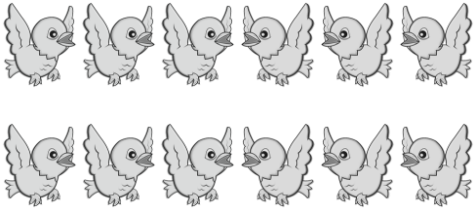
unom 6 unom 6
6 unom 6 unom
6 6

unom unom

Buruhaton 2: Ihapa an drowing ngan igsurat an ngaran ngan simbolo han numero.

1. 	2. 
3. 	4. 
5. 	6. 

Balay Pag-aradman : Ihapa an mga bukad ha kada vase. Igsurat ha iyo papel an kadamo han bukad ha pulong ngan simbolo . Pagdrowing hin grupo hin mga bukad ha pagpakita hin sobra ha usa o iban ha usa.

1. 	Igpakita an sobra hin usa. 
2. 	Igpakita an iban hin usa. 
3. 	Igpakita an sobra hin usa. 





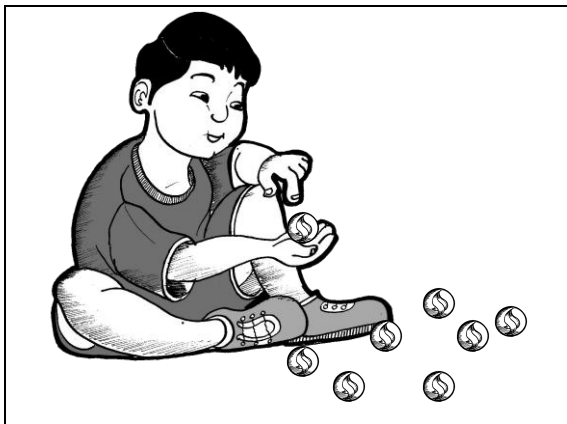

Pito, Walo, Siyam

Pagpahinumdod:

	
	7 pito

	
	8 walo

	
	9 siyam

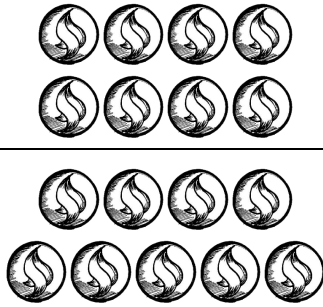
<p>An walo, in usa nga sobra hin pito.</p>	
<p>An siyam, in usa nga sobra hin walo.</p>	
<p>An pito, in walo iban hin usa.</p>	
<p>An walo, In siyam iban hin usa.</p>	
	
	
	

Buruhaton 1.1: Igsiring an numero ngan kopyaha an simbolo ngan pulong ha iyo papel.

The worksheet consists of the following elements:

- A rectangular box containing seven coins arranged in two rows (four in the top row and three in the bottom row).
- Two rows of handwriting practice. Each row has a solid 'pito' and '7' on the left, and a dotted 'pito' and '7' on the right for tracing.
- Two more rows of handwriting practice. Each row has a solid 'pito' and '7' on the left, and a dotted 'pito' and '7' on the right for tracing.
- A final row of handwriting practice with three dotted 'pito' and '7' for independent practice.

Buruhaton 1.2: Igsiring an numero ngan kopyaha an simbolo ngan pulong ha iyo papel.

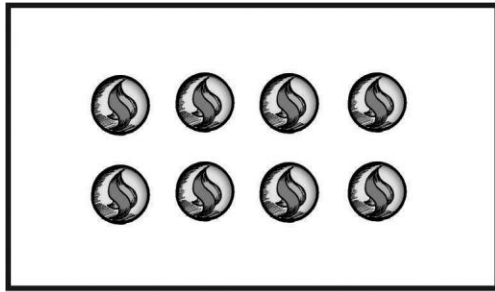

walo walo
8 8

walo walo
8 8

walo walo
8 8

walo 8
8 walo
8 8

walo walo walo

Buruhaton 1.3: Igsiring an numero ngan kopyaha an simbolo ngan pulong ha iyo papel.

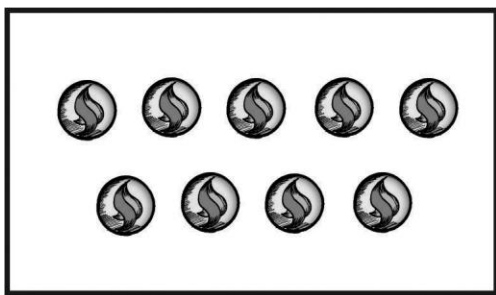

siyam
9

siyam
9

siyam
9

siyam
9

siyam
9





siyam 9
9

siyam 9
9

siyam

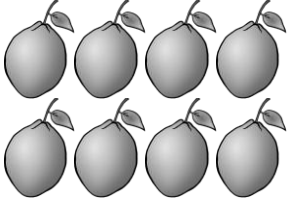

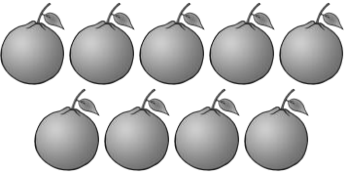
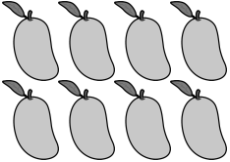
siyam

Buruhaton 2: Ihapa an prutas han kada grupo.
Igsurat an kadamohan prutas ha iyo papel ha
pulong ngan simbolo.

1. 	2. 
3. 	4. 
5. 	6. 

Balay Pag-aradman

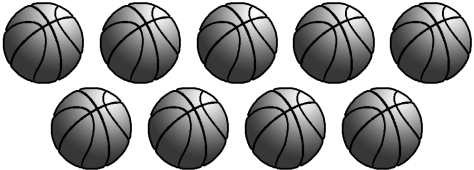
Ihapa an kadamo han bola ha kada grupo. Igsurat ha iyo imo papel an kadamo han bola ha pulong ngan simbolo. Pagdrowing hin grupo hin (🏀) pagpakita hin usa sobra ha usa o kulang han usa.

1. 	Igpakita an sobra hin usa.
2. 	Igpakita an iban hin usa.
3. 	Igpakita an iban hin usa.

Sero

Pagpahinumdom:



Pira an prutas ha **basket**?
1 usa



Pira an prutas ha **basket**?
0 sero

An 1 mas damo han 0.

An 0 mas guti han 1.

Buruhaton 1: Igsiring an numero ngan kopyaha an simbolo ngan pulong ha imo papel.

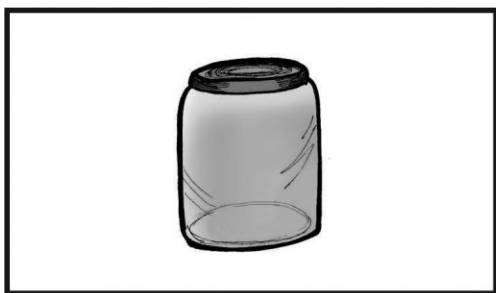

sero
0

sero
0

sero
0

sero
0

sero
0





sero 0
0 sero
0

sero 0
0 sero
0



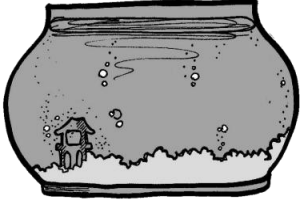
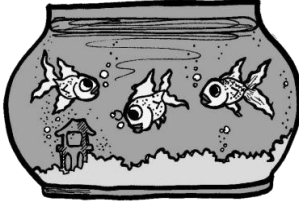

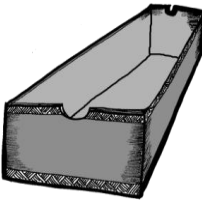
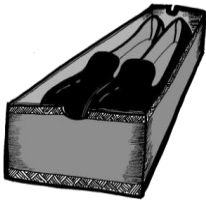

sero

sero

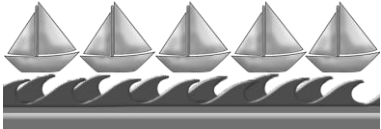
Buruhaton 2: Ihapa an mga butang ha grupo A ngan B. Igsurat ha imo imo papel an letra han grupo nga nagpapakita hin sero.

1.  A	 B
2.  A	 B
3.  A	 B
4.  A	 B

Balay Pag-aradman: Ihapa an sakayan ha kada grupo. Igsurat ha imo papel an kadamo han sakayan ha pulong ngan simbolo. Pagdrowing hin grupo hin sakayan ha pagpakita hin sobra ha usa o iban hin usa.

<p>1.</p>  <hr/> <hr style="border-top: 1px dashed;"/> <hr/>	<p>Igpakita an sobra hin usa.</p>  <hr/> <hr style="border-top: 1px dashed;"/> <hr/>
<p>2</p>  <hr/> <hr style="border-top: 1px dashed;"/> <hr/>	<p>Igpakita an iban hin usa.</p>  <hr/> <hr style="border-top: 1px dashed;"/> <hr/>
<p>3. Igpakita an sobra hin usa.</p>  <hr/> <hr style="border-top: 1px dashed;"/> <hr/>	 <hr/> <hr style="border-top: 1px dashed;"/> <hr/>

Napulo

Pagpahinumdom:

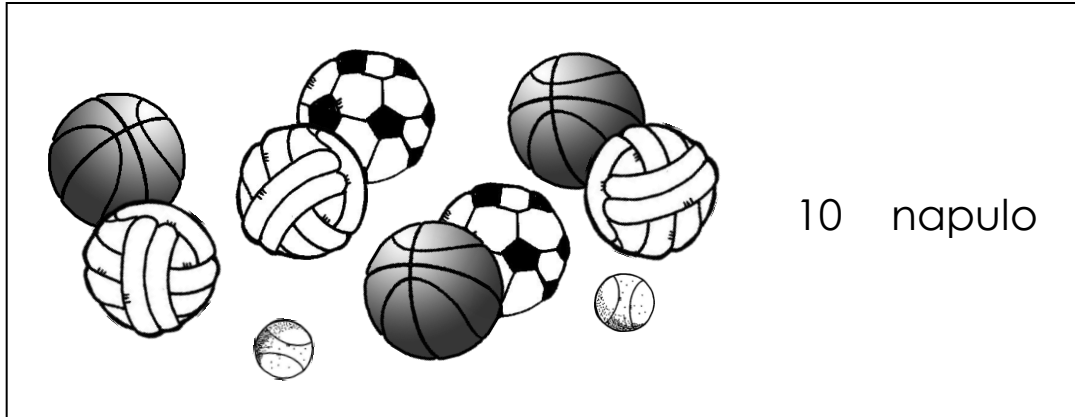

<p>An napulo, in usa nga sobra hin siyam.</p>	<p>10 boys</p>
<p>An siyam, in napulo iban hin usa.</p>	<p>9 boys</p>

Buruhaton 1.1: Igsiring an numero ngan kopyaha an simbolo ngan pulong ha imo papel.

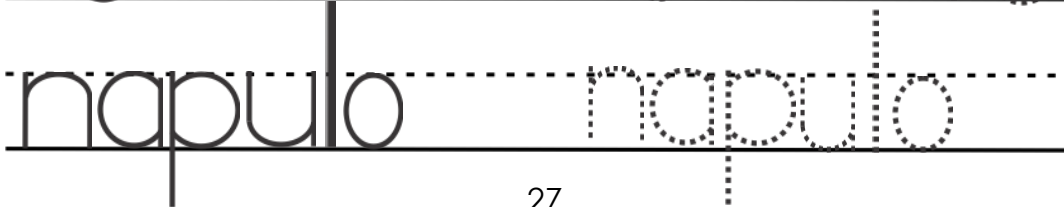
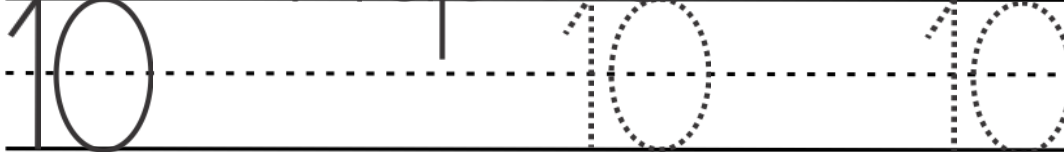
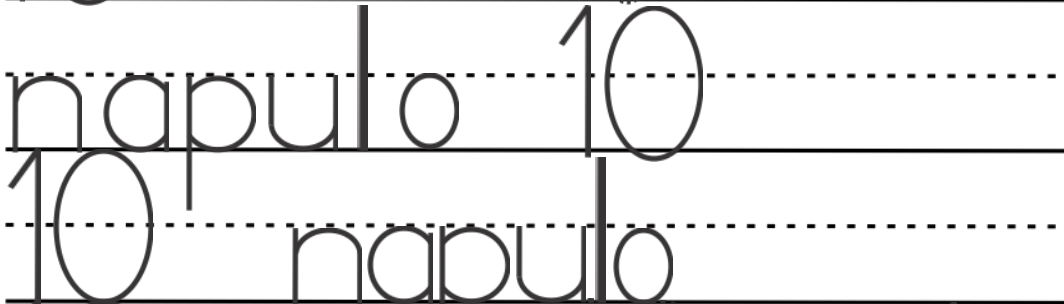
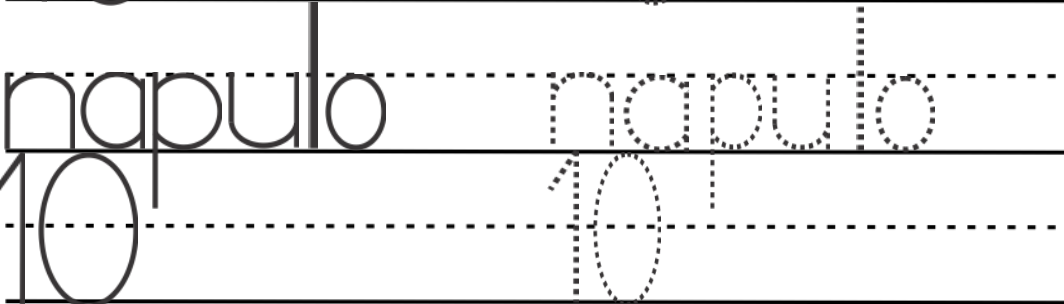
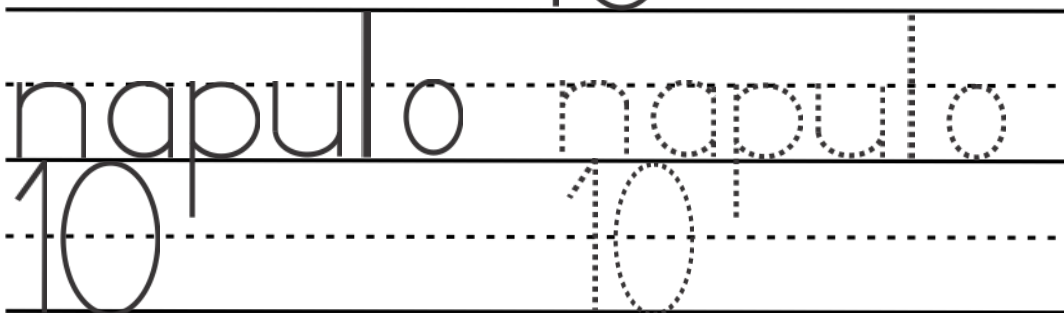
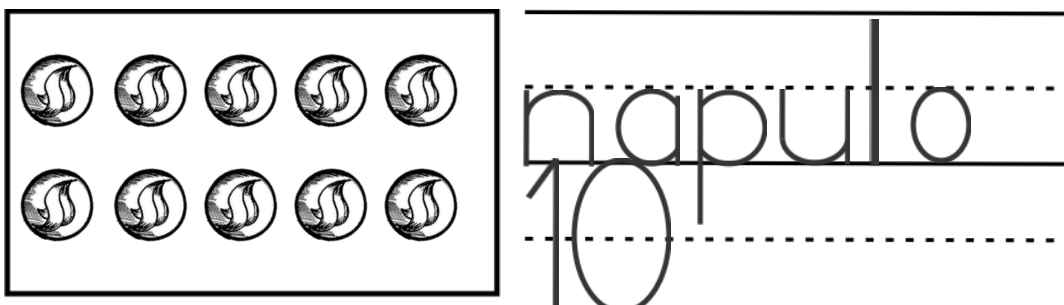

Buruhaton 2: Kitaa an mga drowing ha kada kahon.
Drowinga ngan kolori ha imo papel an mga bola ha
pagpakita han kadamo.

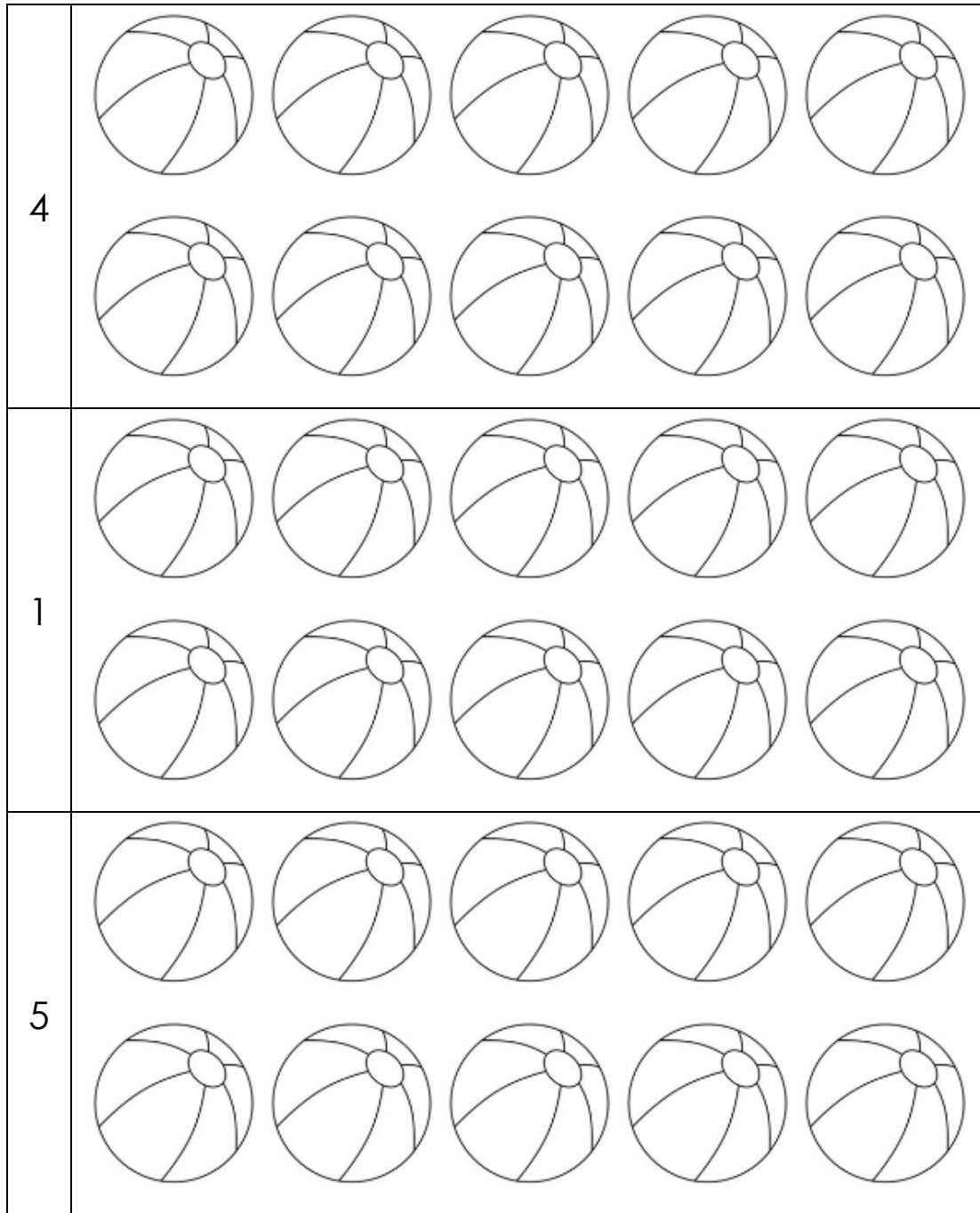

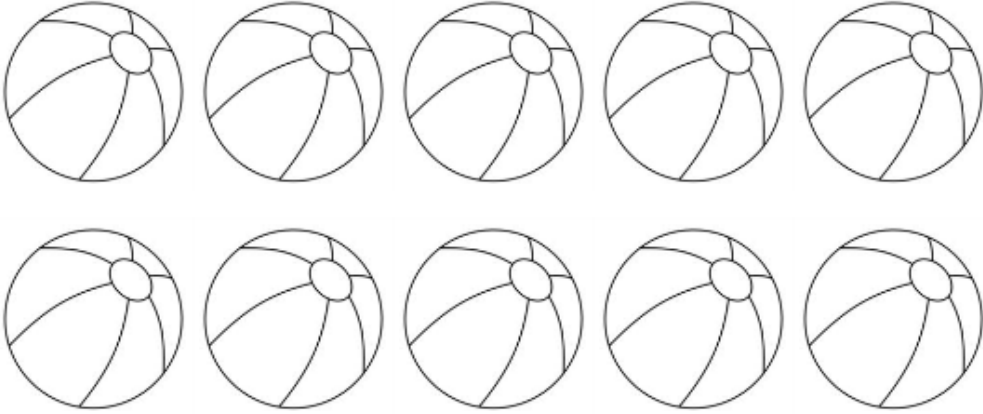
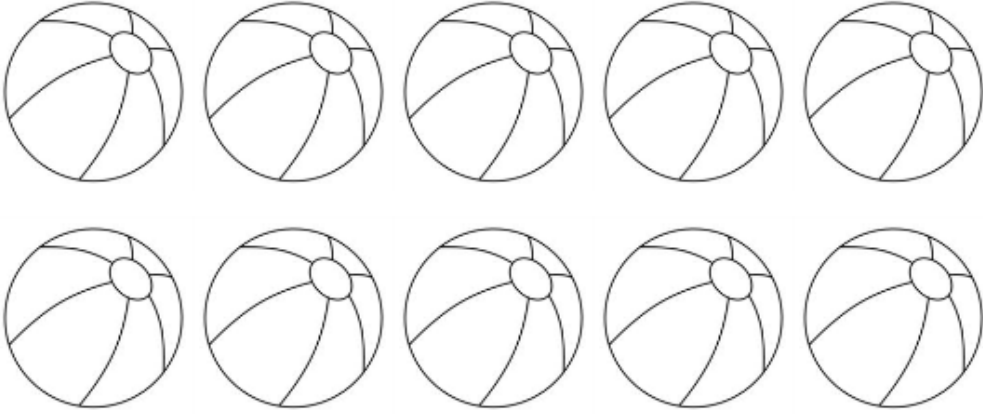
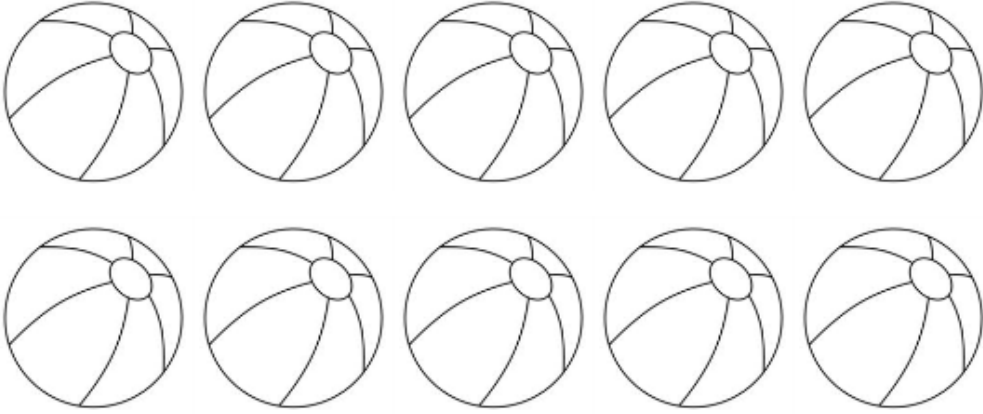
3	 A 2x5 grid of 10 beach balls. Each beach ball is a circle with curved lines representing segments and a small circle at the top representing a valve.
0	 A 2x5 grid of 10 beach balls. Each beach ball is a circle with curved lines representing segments and a small circle at the top representing a valve.
10	 A 2x5 grid of 10 beach balls. Each beach ball is a circle with curved lines representing segments and a small circle at the top representing a valve.

Buruhaton 3: Ihapa kun pipira an uyagan ha kada grupo. Igsurat ha imo papel kun pipira kadamo an mga uyagan ha pulong ngan numero

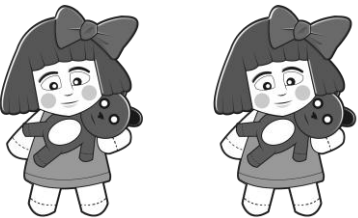
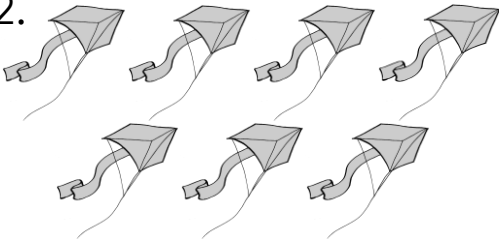
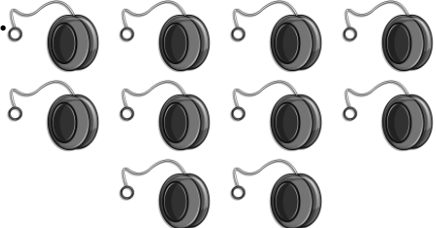
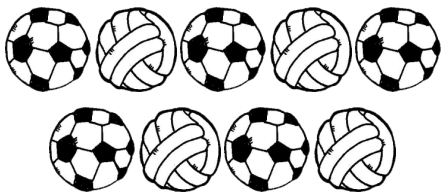
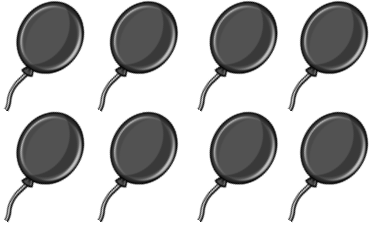
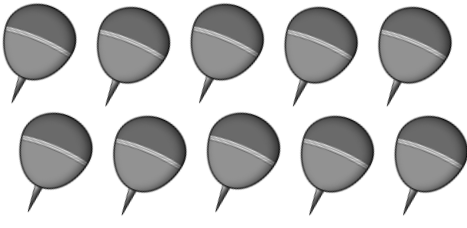
1. 	2. 
3. 	4. 
5. 	6. 





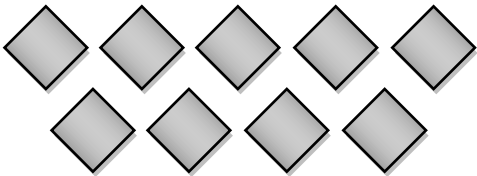
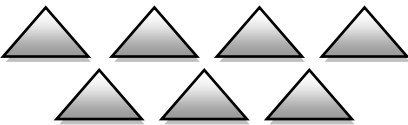

Buruhaton nga Pag-aradman ha Balay

Ihapa kun pipira an mga butang ha kada grupo ngan Igsurat ha imo papel an kadamo han butang ha pulong ngan simbolo. Pagdrowing hin grupo hin mga butang pagpakita han sobra hin usa o iban hin usa



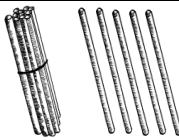
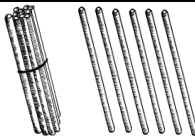
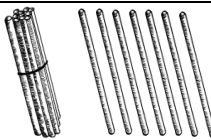
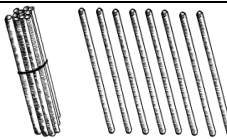
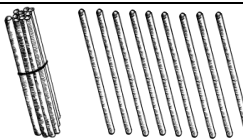

1. 	Igpakita an iban hin usa.
2. Igpakita an sobra hin usa.	
3. 	Igpakita an iban hin usa.

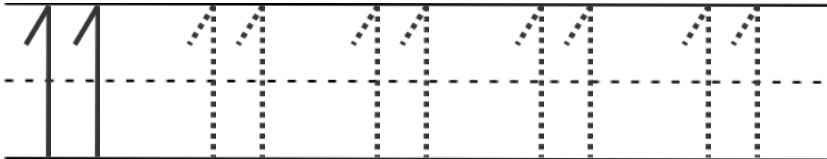

Onse ngadto Baynte

Pagpahinumdom:

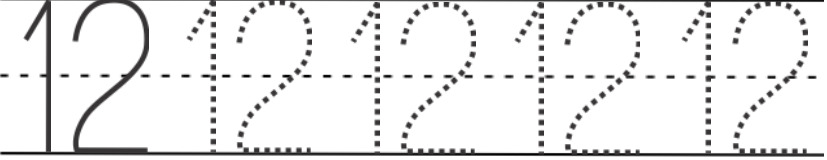
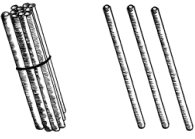
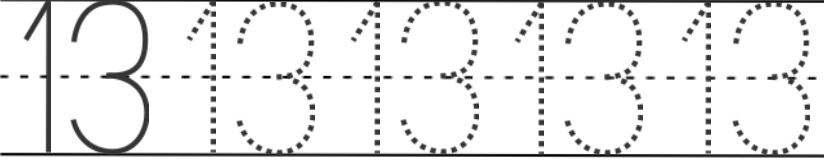

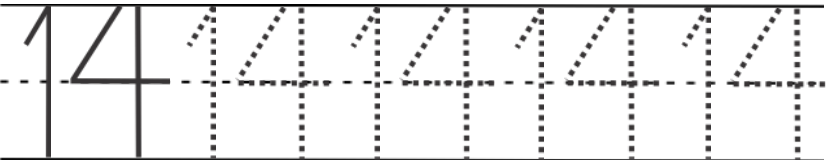
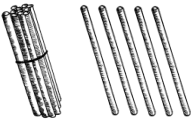
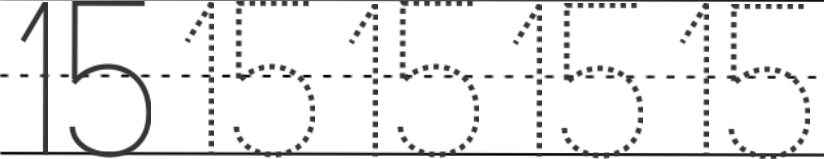

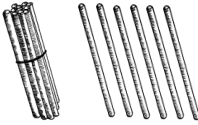
	<table border="1" style="width: 100%; text-align: center;"> <tr> <td style="width: 50%;">tagnapulo</td> <td style="width: 50%;">tag-usa</td> </tr> <tr> <td>1</td> <td>1</td> </tr> </table>	tagnapulo	tag-usa	1	1	11
tagnapulo	tag-usa					
1	1					
	<table border="1" style="width: 100%; text-align: center;"> <tr> <td style="width: 50%;">tagnapulo</td> <td style="width: 50%;">tag-usa</td> </tr> <tr> <td>1</td> <td>2</td> </tr> </table>	tagnapulo	tag-usa	1	2	12
tagnapulo	tag-usa					
1	2					
	<table border="1" style="width: 100%; text-align: center;"> <tr> <td style="width: 50%;">tagnapulo</td> <td style="width: 50%;">tag-usa</td> </tr> <tr> <td>1</td> <td>3</td> </tr> </table>	tagnapulo	tag-usa	1	3	13
tagnapulo	tag-usa					
1	3					
	<table border="1" style="width: 100%; text-align: center;"> <tr> <td style="width: 50%;">tagnapulo</td> <td style="width: 50%;">tag-usa</td> </tr> <tr> <td>1</td> <td>4</td> </tr> </table>	tagnapulo	tag-usa	1	4	14
tagnapulo	tag-usa					
1	4					
	<table border="1" style="width: 100%; text-align: center;"> <tr> <td style="width: 50%;">tagnapulo</td> <td style="width: 50%;">tag-usa</td> </tr> <tr> <td>1</td> <td>5</td> </tr> </table>	tagnapulo	tag-usa	1	5	15
tagnapulo	tag-usa					
1	5					
	<table border="1" style="width: 100%; text-align: center;"> <tr> <td style="width: 50%;">tagnapulo</td> <td style="width: 50%;">tag-usa</td> </tr> <tr> <td>1</td> <td>6</td> </tr> </table>	tagnapulo	tag-usa	1	6	16
tagnapulo	tag-usa					
1	6					
	<table border="1" style="width: 100%; text-align: center;"> <tr> <td style="width: 50%;">tagnapulo</td> <td style="width: 50%;">tag-usa</td> </tr> <tr> <td>1</td> <td>7</td> </tr> </table>	tagnapulo	tag-usa	1	7	17
tagnapulo	tag-usa					
1	7					
	<table border="1" style="width: 100%; text-align: center;"> <tr> <td style="width: 50%;">tagnapulo</td> <td style="width: 50%;">tag-usa</td> </tr> <tr> <td>1</td> <td>8</td> </tr> </table>	tagnapulo	tag-usa	1	8	18
tagnapulo	tag-usa					
1	8					
	<table border="1" style="width: 100%; text-align: center;"> <tr> <td style="width: 50%;">tagnapulo</td> <td style="width: 50%;">tag-usa</td> </tr> <tr> <td>1</td> <td>9</td> </tr> </table>	tagnapulo	tag-usa	1	9	19
tagnapulo	tag-usa					
1	9					
	<table border="1" style="width: 100%; text-align: center;"> <tr> <td style="width: 50%;">tagnapulo</td> <td style="width: 50%;">tag-usa</td> </tr> <tr> <td>2</td> <td>0</td> </tr> </table>	tagnapulo	tag-usa	2	0	20
tagnapulo	tag-usa					
2	0					

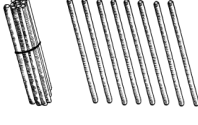
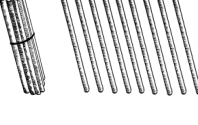
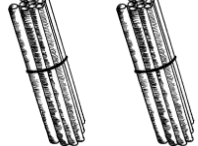
Buruhaton 1: Ihapa an mga **stick** ha kada grupo.
Igsurat an kadamo han **sticks** ha imo papel.

	<p>16 16 16 16 16</p>
	<p>17 17 17 17 17</p>
	<p>18 18 18 18 18</p>
	<p>19 19 19 19 19</p>
	<p>20 20 20 20 20</p>

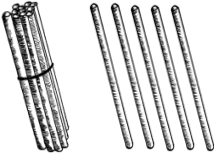
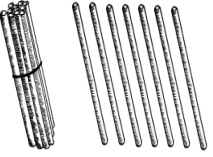
Buruhaton 2: Ihapa an mga **sticks** ha kada grupo.
Igsurat an kadamo han **sticks** ha imo papel.

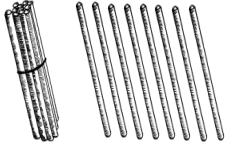

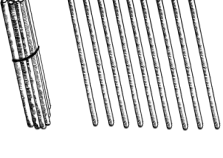
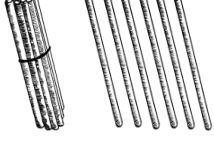
	<hr/> <hr style="border-top: 1px dashed;"/> <hr/>		<hr/> <hr style="border-top: 1px dashed;"/> <hr/>
	<hr/> <hr style="border-top: 1px dashed;"/> <hr/>		<hr/> <hr style="border-top: 1px dashed;"/> <hr/>
	<hr/> <hr style="border-top: 1px dashed;"/> <hr/>		<hr/> <hr style="border-top: 1px dashed;"/> <hr/>
	<hr/> <hr style="border-top: 1px dashed;"/> <hr/>		<hr/> <hr style="border-top: 1px dashed;"/> <hr/>
	<hr/> <hr style="border-top: 1px dashed;"/> <hr/>		<hr/> <hr style="border-top: 1px dashed;"/> <hr/>

Buruhaton 3: Pagdrowing ha imo papel hin mga butang nga nagpapakita han nasunod nga mga numero. Igsurat an kadamo ha ubos han imo drowing.

Numero	Drowing
17	
11	
15	
20	
13	
16	
18	
12	
19	
14	

Balay Pag-aradman : Ihapa an kadamo han mga butang ha kada grupo. Ha imo papel lgsurat an kadamo han butang pinaagi kun pipira:

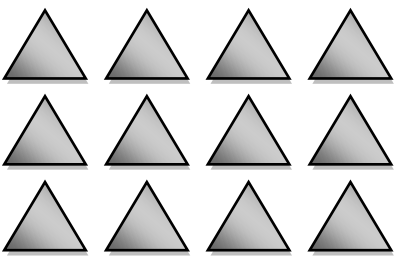
- a. an mga butang tanan
- b. tagnapulo ngan tag-usa

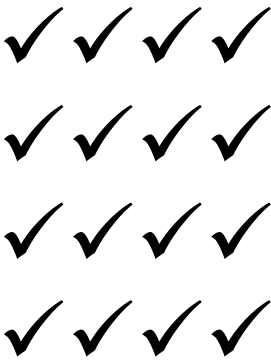
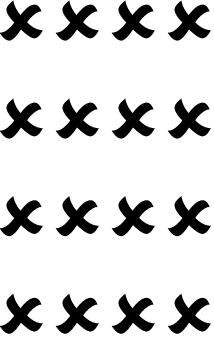
<p>1.</p>  <p>_____ ngatanan _____ tagnapulo _____ tag-usa</p>	<p>2.</p>  <p>_____ ngatanan _____ tagnapulo _____ tag-usa</p>
<p>3.</p>  <p>_____ ngatanan _____ tagnapulo _____ tag-usa</p>	<p>4.</p>  <p>_____ ngatanan _____ tagnapulo _____ tag-usa</p>

5.

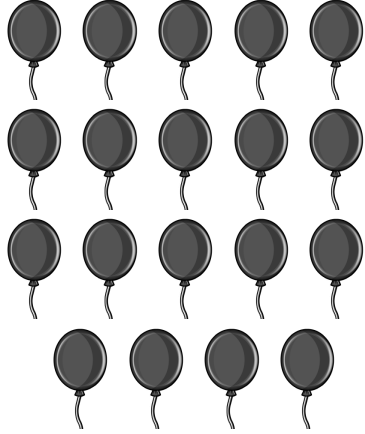

_____ ngatanan
 _____ tagnapulo
 _____ tag-usa

6.

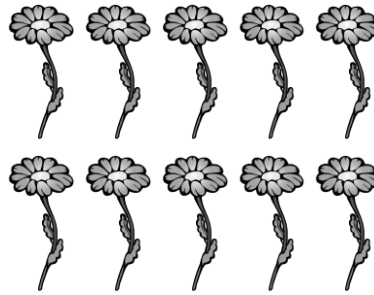

_____ ngatanan
 _____ tagnapulo
 _____ tag-usa

7.

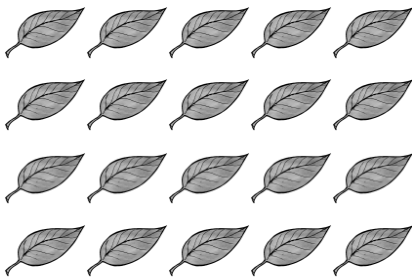

_____ ngatanan
 _____ tagnapulo
 _____ tag-usa

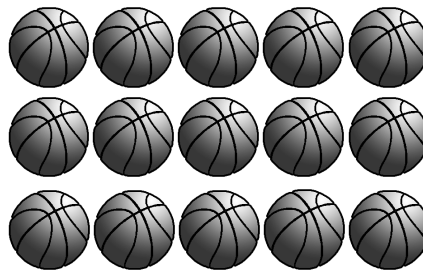

8.







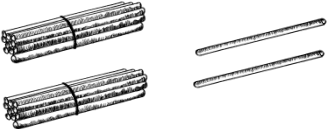
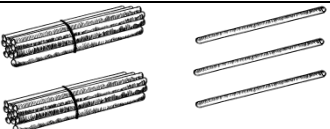
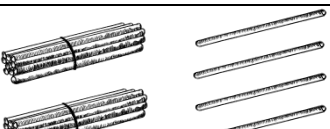
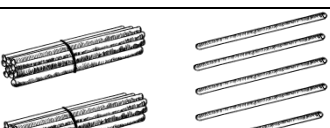





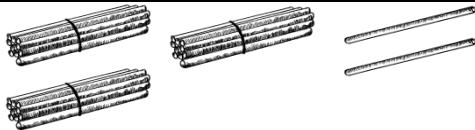

_____ ngatanan
 _____ tagnapulo
 _____ tag-usa

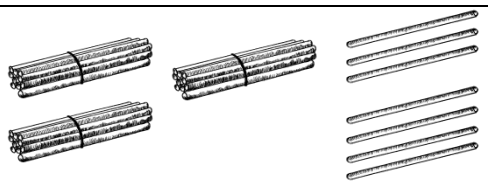
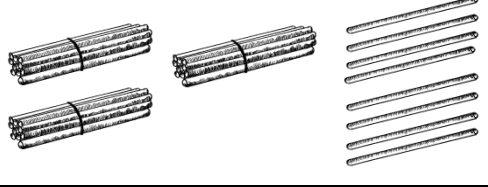
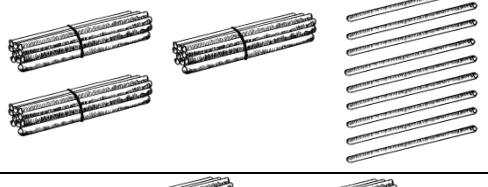

Baynte-Uno ngadto Singkwenta

Pagpahinumdom:

Numero	Kinabubutangan han Balor	
	Tagnapulo	Tag- usa
	21	2 1
	22	2 2
	23	2 3
	24	2 4
	25	2 5
	26	2 6
	27	2 7

Numero	Kinabubutangan han Balor	
	Tagnapulo	Tag-usa
	28	2 8
	29	2 9
	30	3 0
	31	3 1
	32	3 2
	33	3 3
	34	3 4
	35	3 5

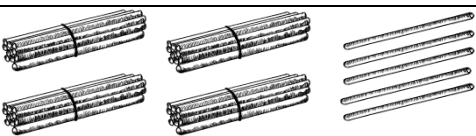
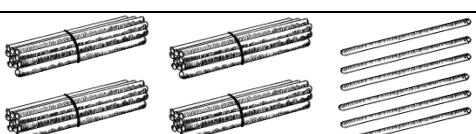
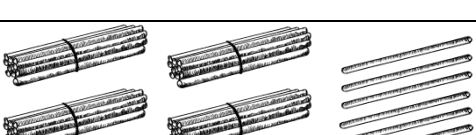
Numero		Kinabubutangan han Balor	
		Tagnapulo	Tag- usa
	36	3	6
	37	3	7
	38	3	8
	39	3	9
	40	4	0
	41	4	1
	42	4	2
	43	4	3

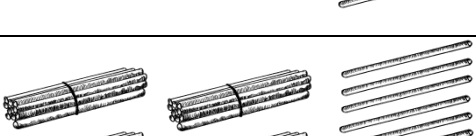
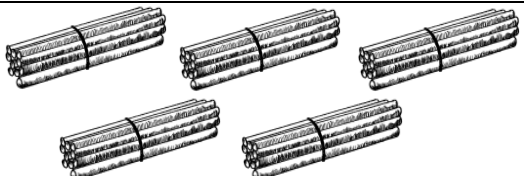
Numero	Kinabubutangan han Balor		
	Tagnapulo	Tag- usa	
	44	4	4
	45	4	5
	46	4	6
	47	4	7
	48	4	8
	49	4	9
	50	5	0

Buruhaton 1: Ihapa an kadamo han mga **sticks** ha kada grupo. Igsurat ha iyo papel an kadamo ngan an iya tagnapulo ngan tag-usa nga numero. An syahan ginbuhat na para imo.

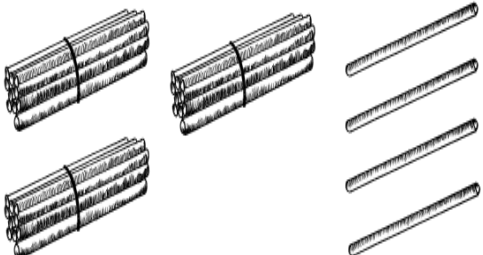
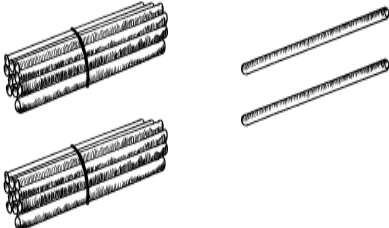
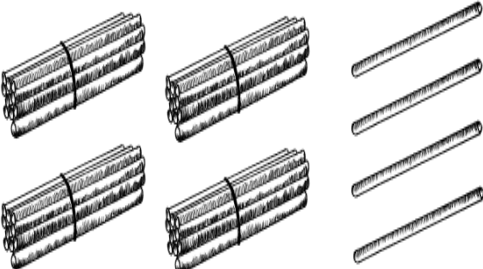
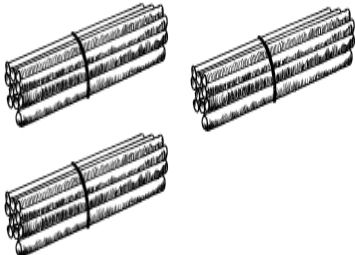
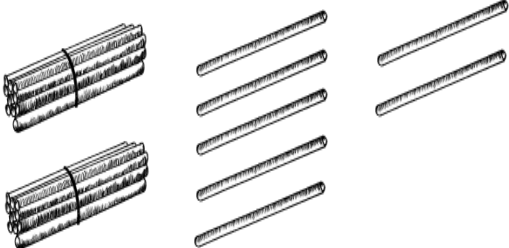
	34	___ 3 ___ tagnapulo ___ 4 ___ tag-usa
		___ tagnapulo ___ tag-usa
		___ tagnapulo ___ tag-usa
		___ tagnapulo ___ tag-usa
		___ tagnapulo ___ tag-usa

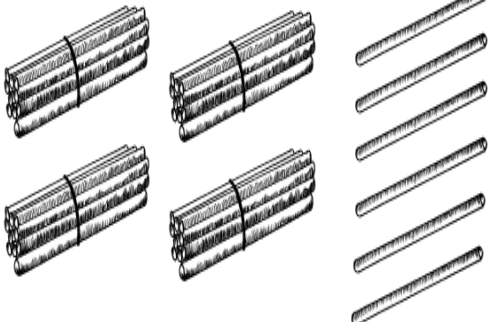
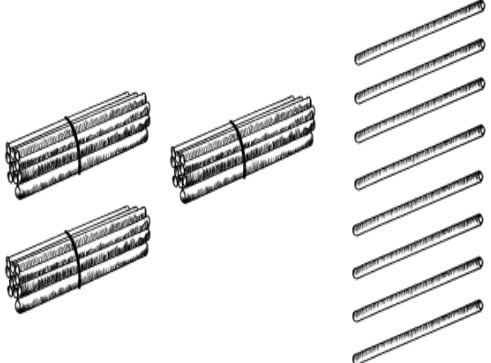
		<p>_____ tagnapulo</p> <p>_____ tag-usa</p>
		<p>_____ tagnapulo</p> <p>_____ tag-usa</p>

Buruhaton 2: Ihapa an mga lidong ha kada grupo. Igsiring kun pira nga tagnapulo ngan tag-usa. Igsumat an iya kabug-usan nga numero.

1.

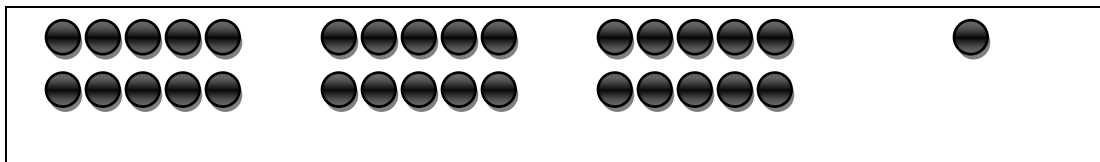

Tagnapulo	Tag-usa

2.

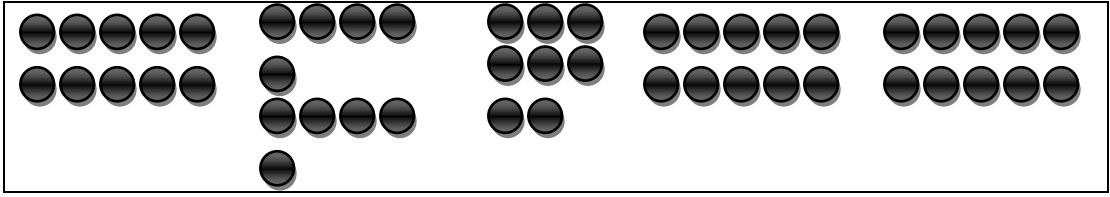

tagnapulo | tag-usa

3.

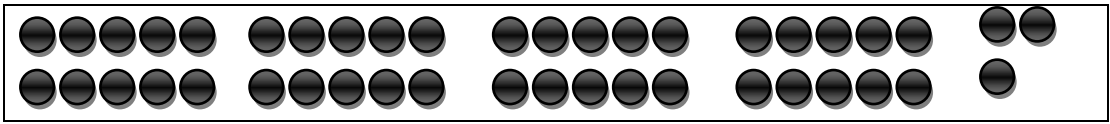

tagnapulo | tag-usa

4.



tagnapulo | tag-usa

5.

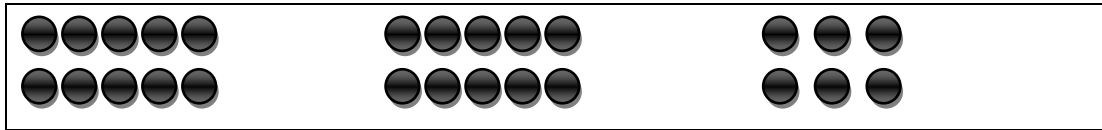

Tagnapulo	Tag-usa
[Empty box for the answer]	

Pagpadig-on han Gin-adman

Buruhaton 3: Kitaa an drowing ha kada rumbay. Drowinga ngan kolori ha iyo **notebook** an mga butang ha pagpakita han hinatag nga numero

1. Kolori an 37

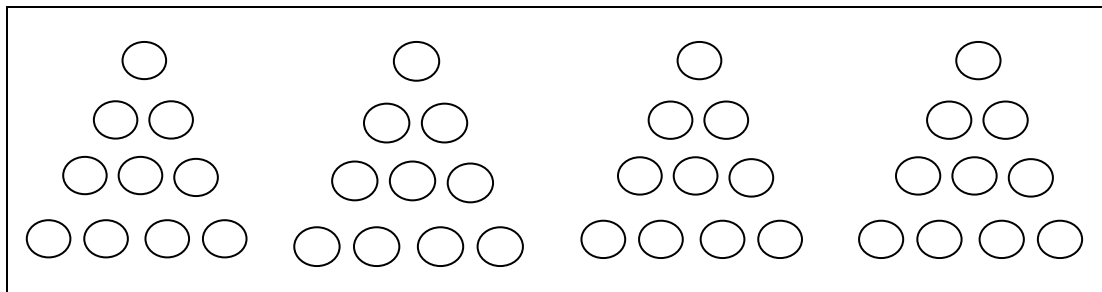

2. Kolori an 40

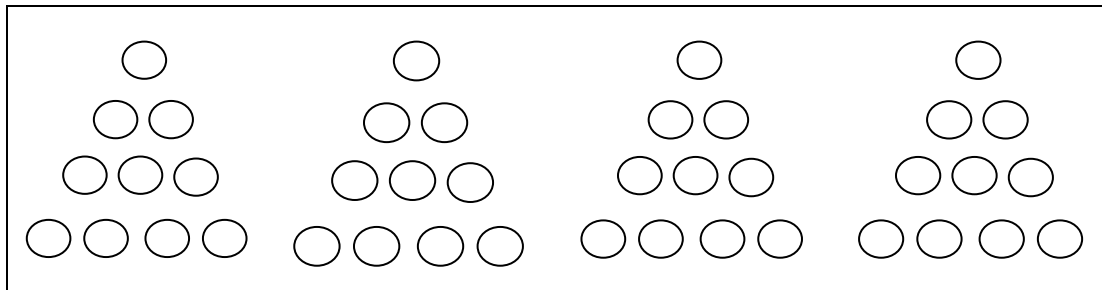

3. Kolori an 25

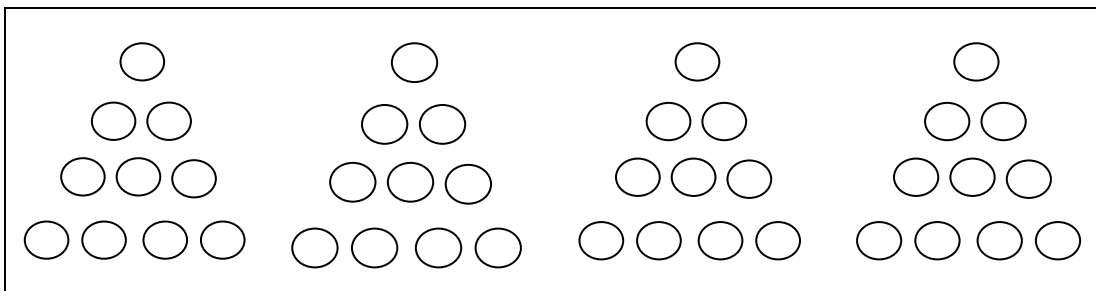

4. Kolori an 28

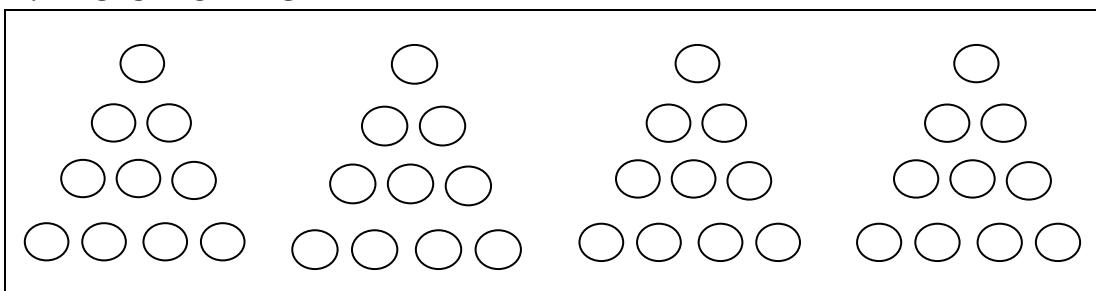

5. Kolori an 33

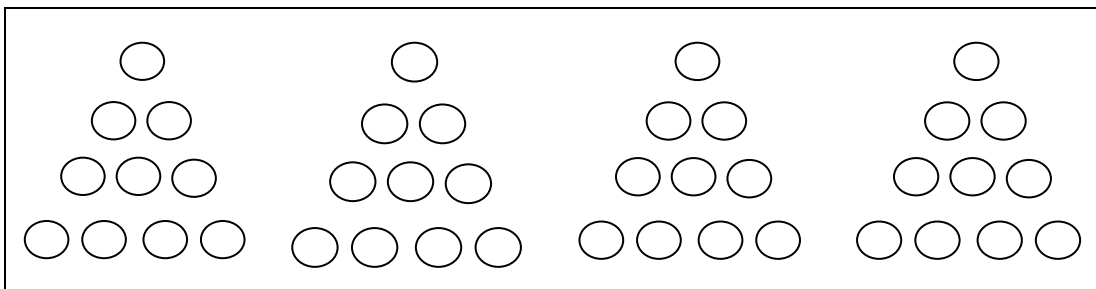









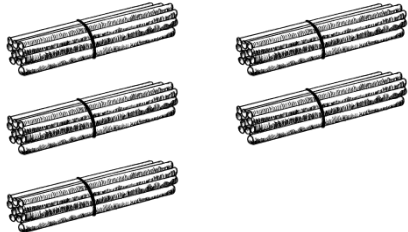

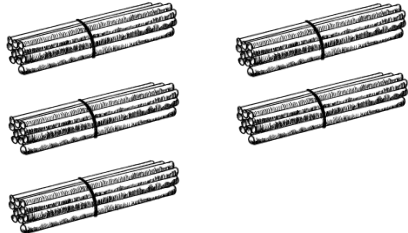

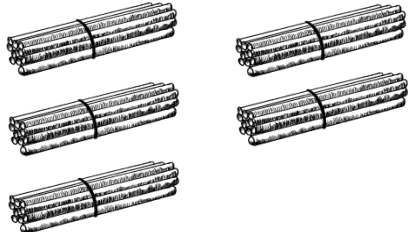
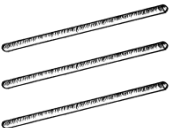
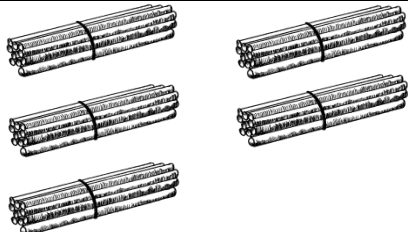
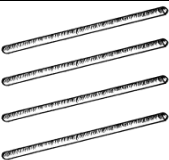
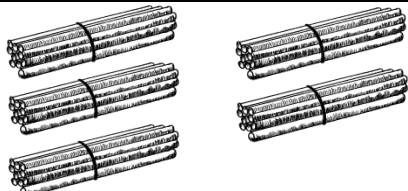
Balay Pag-aradman: Kopyaha an tsart ha imo **notebook**. Igsurat an nawawara nga mga numero.

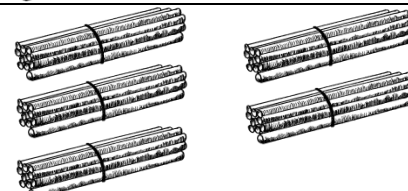

1	2		4			7		9	
	12	13		15			18		20
21		23			26		28		
	32		34		36		38		40
41		43		45		47		49	

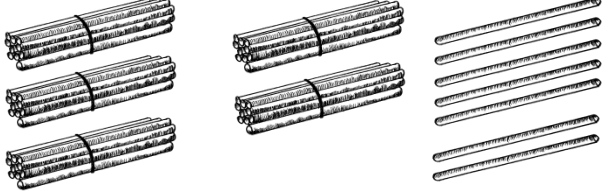
Singkuwenta Ngadto Usa ka Gatos

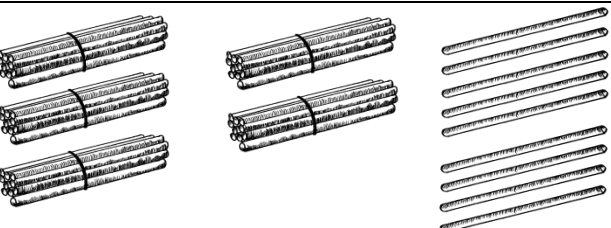
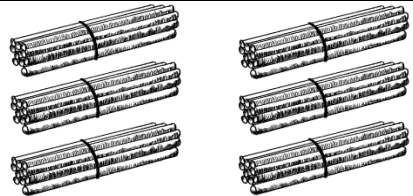
Pagpahinumdom:

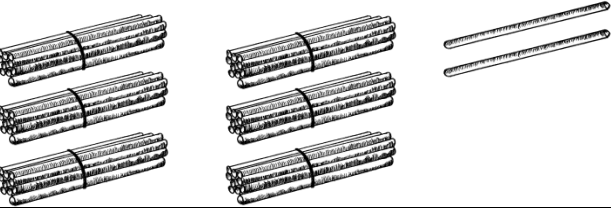
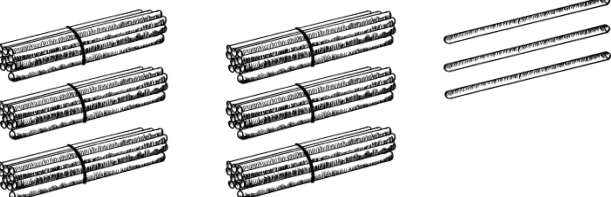
			Numero	Kinabubutang an han Balor	
				Tagna pulo	Tag-usa
			51	5	1
			52	5	2
			53	5	3
			54	5	4
			55	5	5
			56	5	6

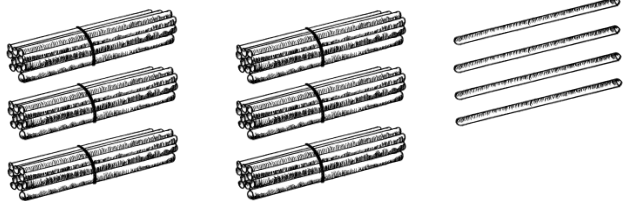
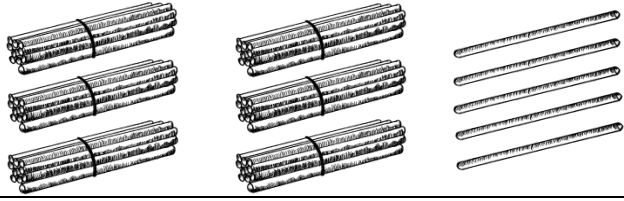
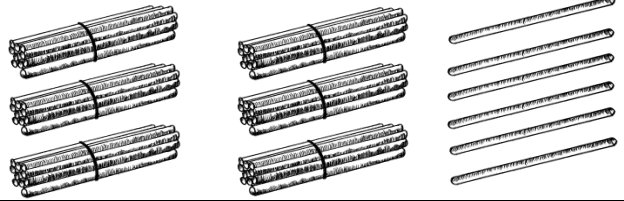
	Numero	Kinabubutangan Baloran	
		Tagapulo	Tag-usa
	57	5	7
	58	5	8
	59	5	9
	60	6	0
	61	6	1
	62	6	2
	63	6	3

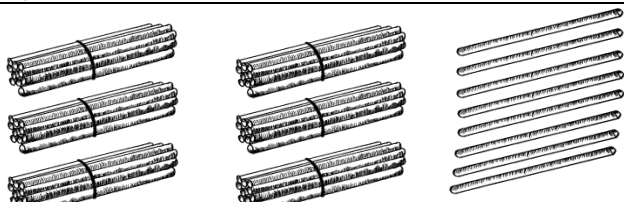
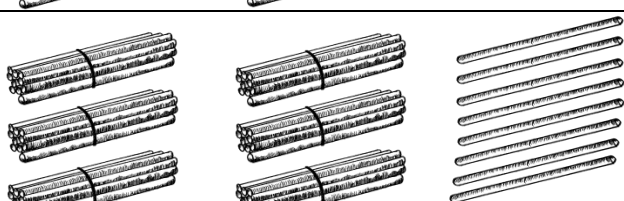
	Numero	Kinabubutangan Baloran	
		Tagapulo	Tag-usa
	64	6	4
	65	6	5
	66	6	6
	67	6	7
	68	6	8
	69	6	9

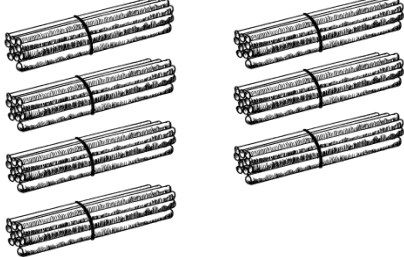
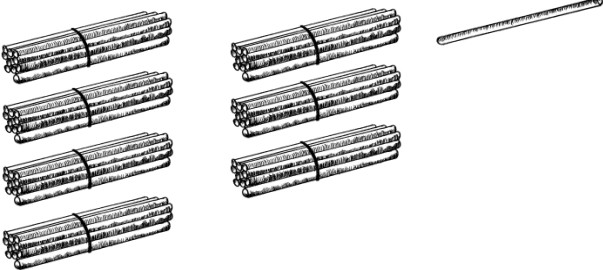
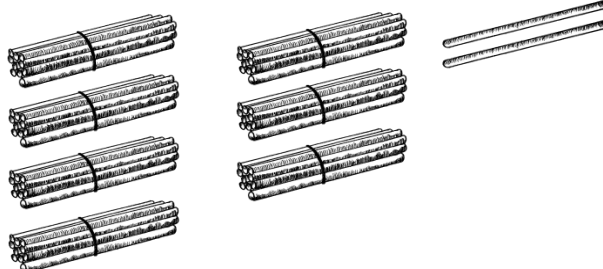
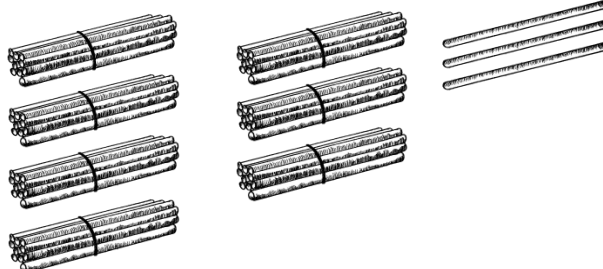
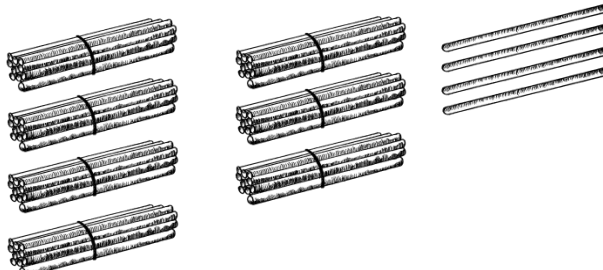

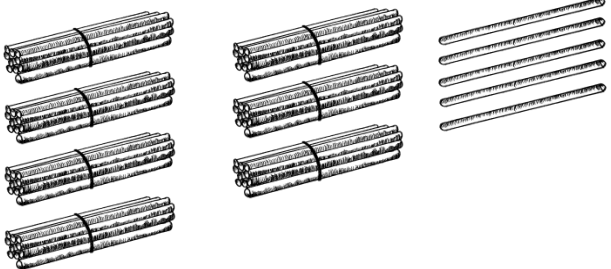
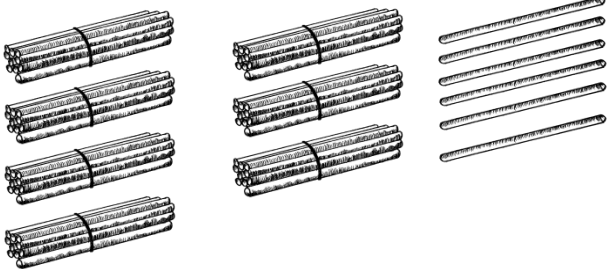
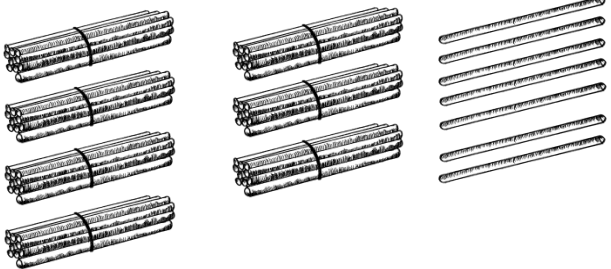
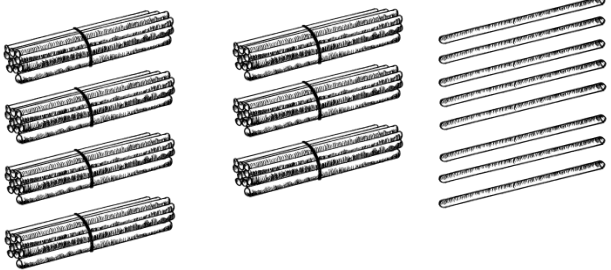
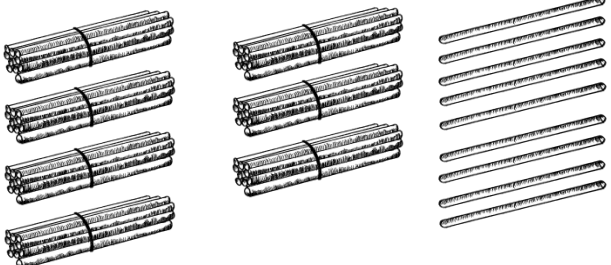

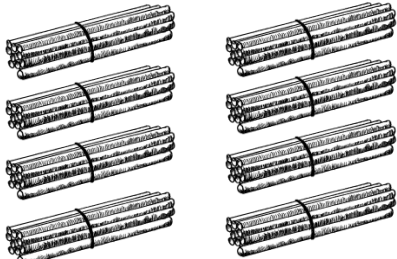
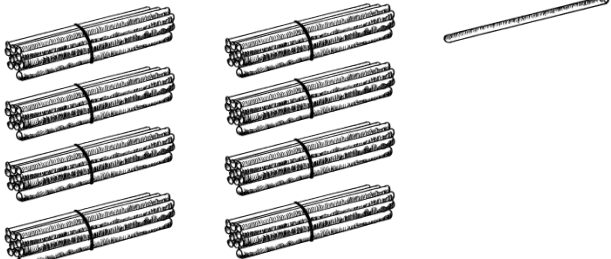
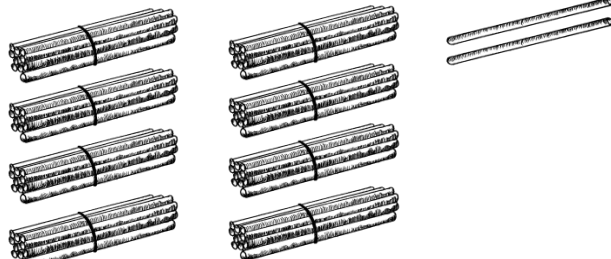
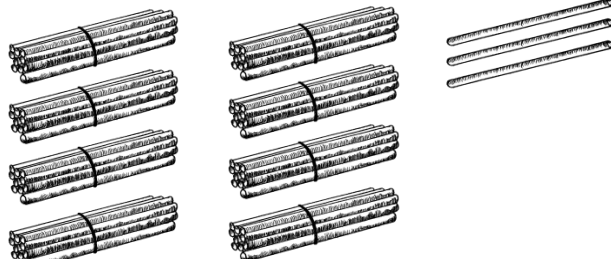
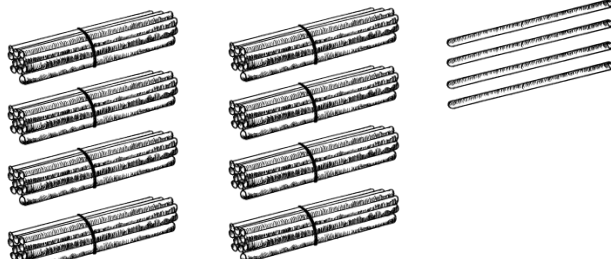

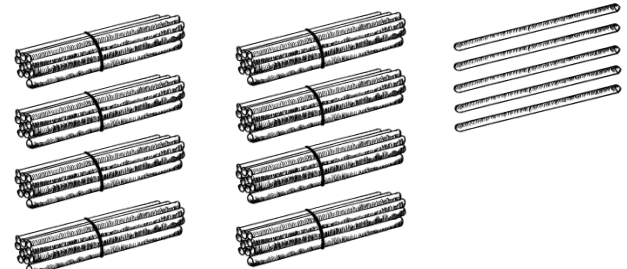
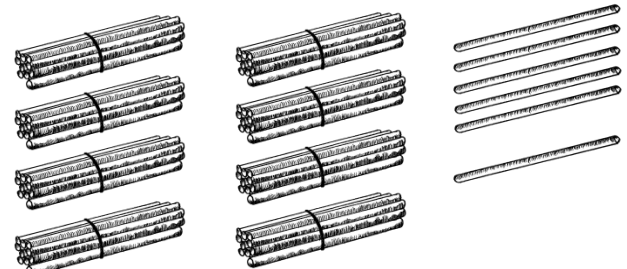
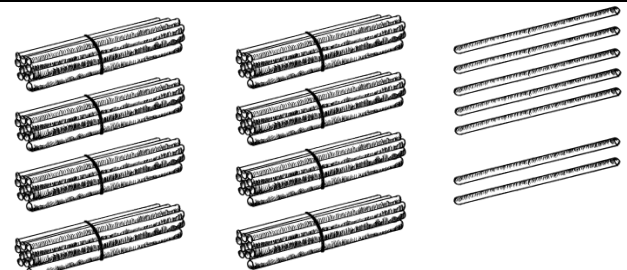
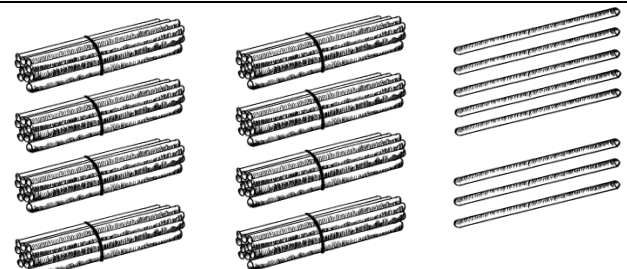
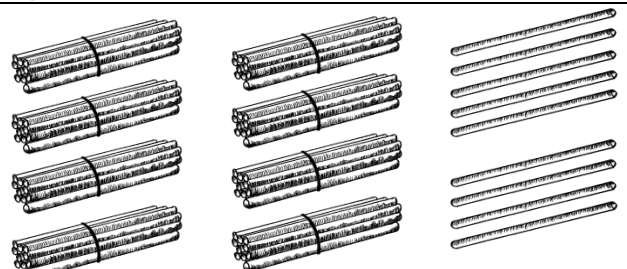
	Numero	Kinabubutangan Baloran	
		Tagapulo	Tag-usa
	70	7	0
	71	7	1
	72	7	2
	73	7	3
	74	7	4

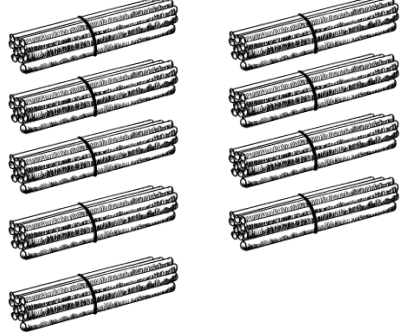
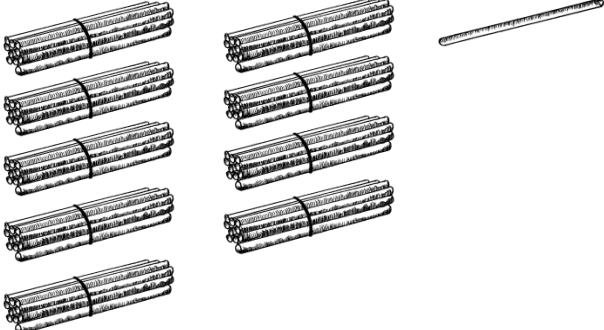
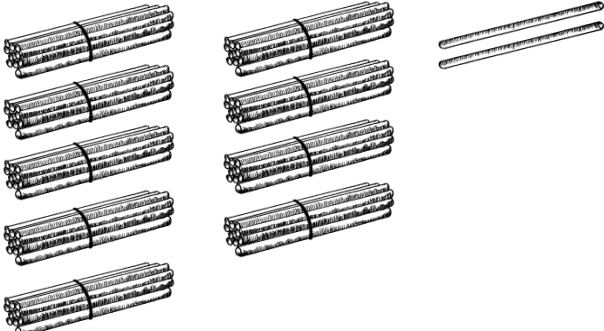
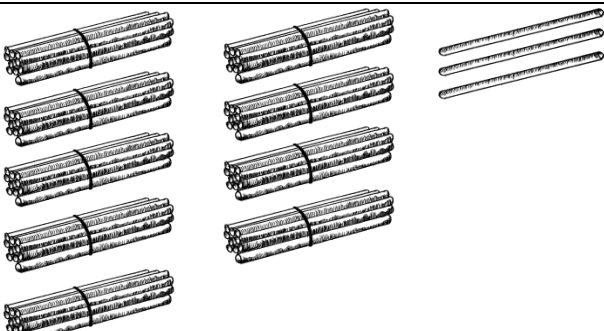
	Numero	Kinabubutangan han Balor	
		Tagnapulo	Tag-usa
	75	7	5
	76	7	6
	77	7	7
	78	7	8
	79	7	9

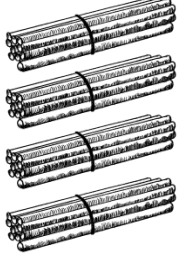
	Numero	Kinabubutangan han Balor	
		Tagnapulo	Tag-usa
	80	8	0
	81	8	1
	82	8	2
	83	8	3
	84	8	4

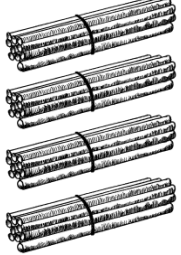
	Numero	Kinabubutangan Baloran	
		Tagapulo	Tag-usa
	85	8	5
	86	8	6
	87	8	7
	88	8	8
	89	8	9

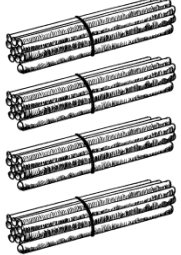
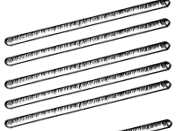
	Numero	Kinabubutangan Baloran	
		Tagapulo	Tag-usa
	90	9	0
	91	9	1
	92	9	2
	93	9	3

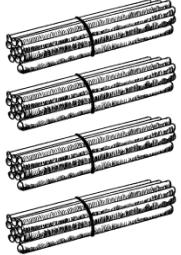
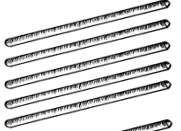
			Numero	Kinabubutangan han Balor	
				Tagnapulo	Tag-usa
			94	9	4
			95	9	5
			96	9	6
			97	9	7

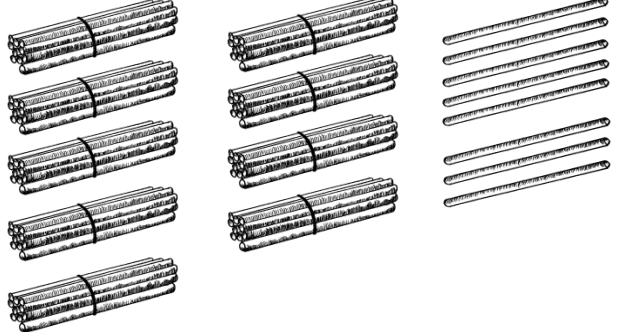
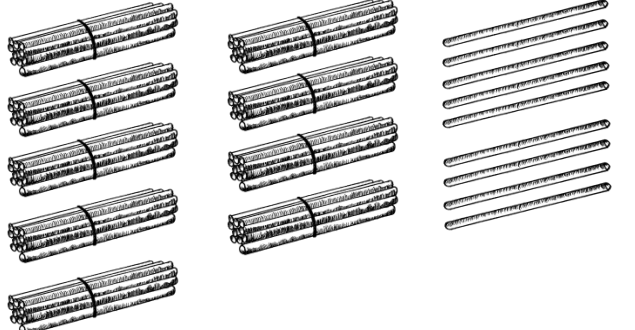
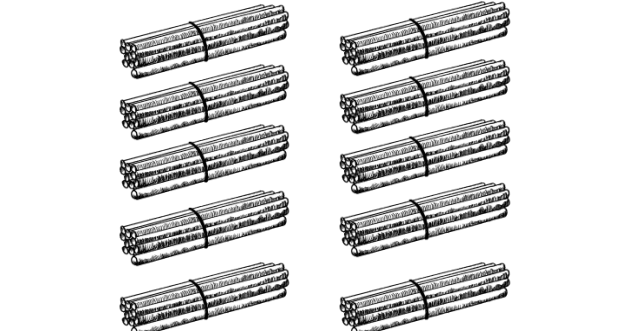
	Numero	Kinabubutangan Baloran	
		Tagapulo	Tag-usa
	98	9	8
	99	9	9
	100	10	0

Buruhaton 1: Ihapa an mga **stick** ha kada grupo. Igsurat ha imo papel an kadamo ngan an tagnapulo ngan tag-usa. An syahan ginbuhat na para ha imo.

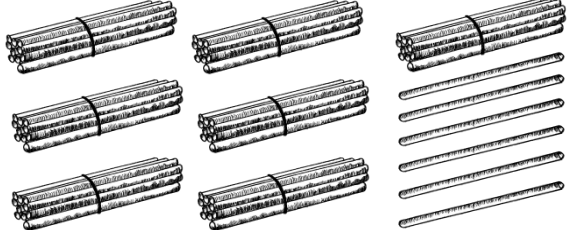
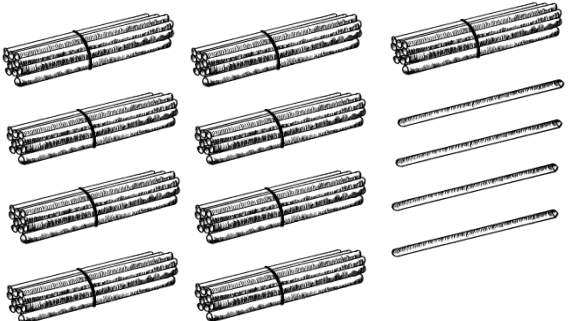
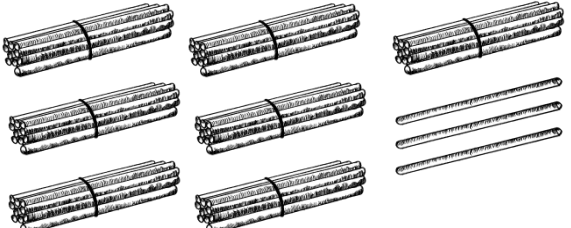
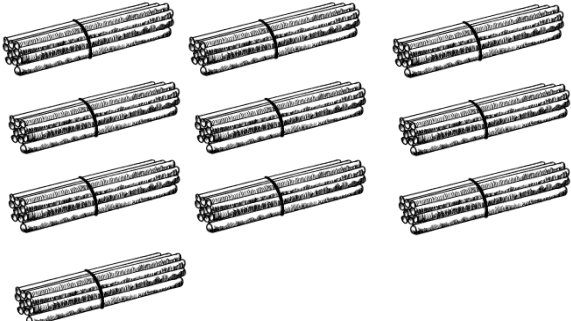
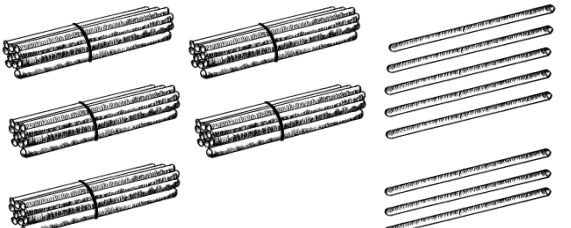
	77	<u>7</u> tagnapulo <u>7</u> tag-usa
		___ tagnapulo ___ tag-usa
		___ tagnapulo ___ tag-usa
		___ tagnapulo ___ tag-usa
		___ tagnapulo ___ tag-usa

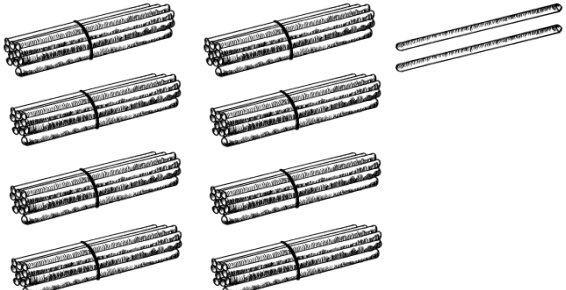
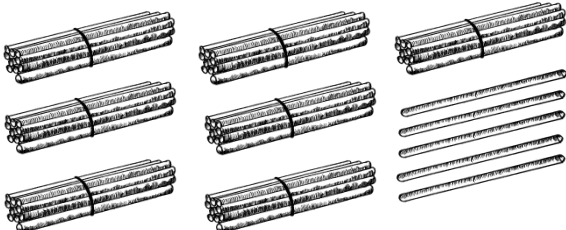
		<p>___ tagnapulo</p> <p>___ tag-usa</p>
		<p>___ tagnapulo</p> <p>___ tag-usa</p>

Buruhaton 2: Ihapa an mga butang ha kada grupo. Isiring kun pira nga tagnapulo ngan tag-usa ngan ihatag an iya kabug-usan nga kadamo.

1.

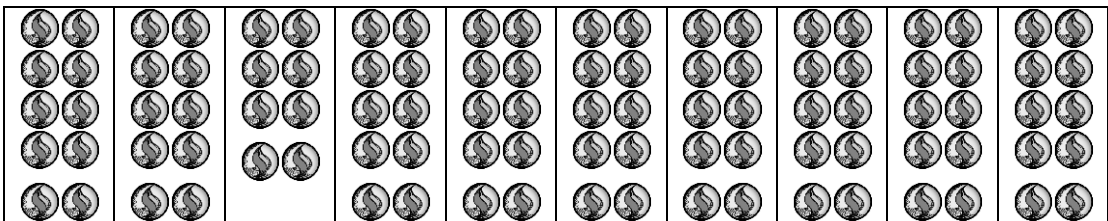

Tagnapulo	Tag-usa

4.

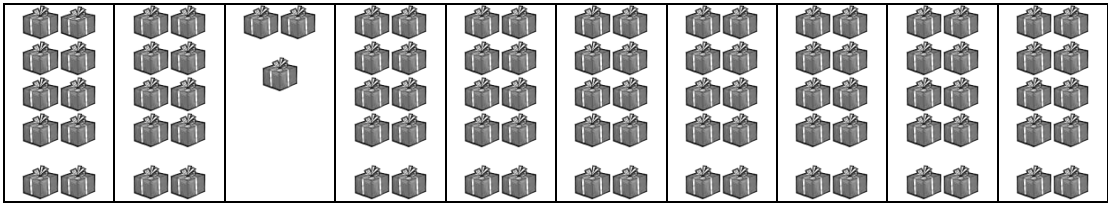

tagnapulo tag-usa

5.



tagnapulo tag-usa

Buruhaton 3: Ihapa ngan pilia an eksakto an baton.

1.

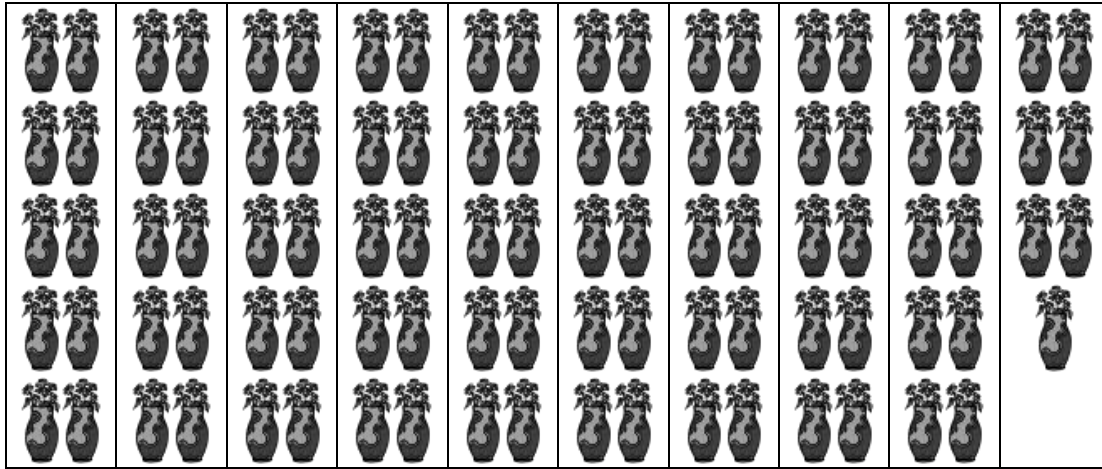

100

99

97

2.

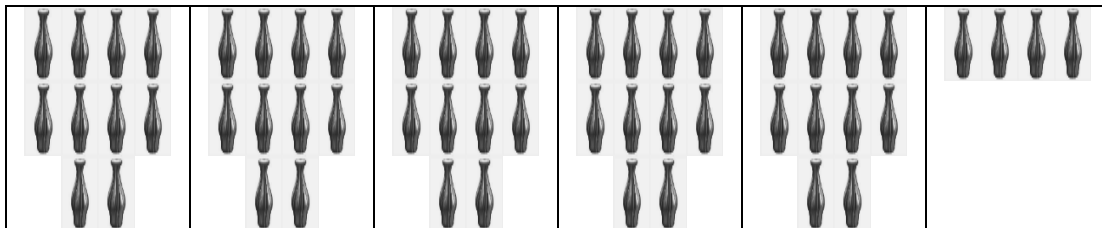

45

54

60

3.

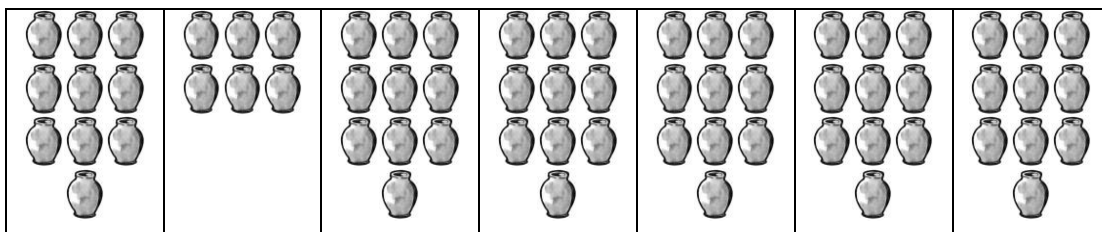

53

66

70

4.

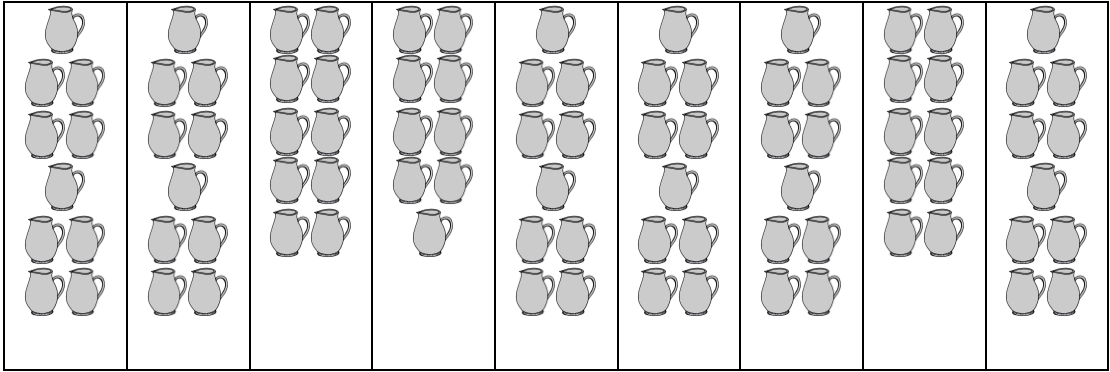

89

99

100

5.

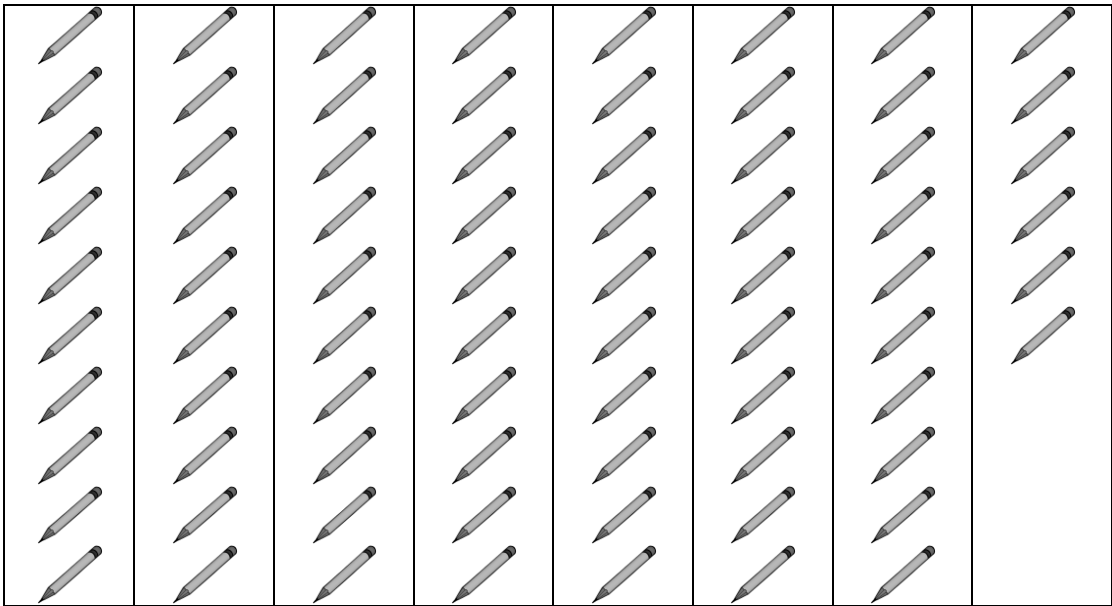

70

76

80

Balay Pag-aradman. Kopyaha an tsart ha imo **notebook.** Igsurat an nawawara nga mga numero

	2		4		6		8		10
11		13		15		17		19	
	22		24		26				30
31		33		35			38		
		43			46			49	
51			54		56		58		60
	62			65		67		69	
		73			76		78		80
	82		84			87		89	
91		93		95			98		

Sobra hin Usa

Pagpahinumdom:

Nakakarawat hi Paolo hin duha ka grupo nga regalo han iya kaadlawan. Nakakuha hiya hin mas damo nga aru-awto kontra han bola.

Eksakto ba an ihap ni Paolo? Paunan-o mo nahibaroan?

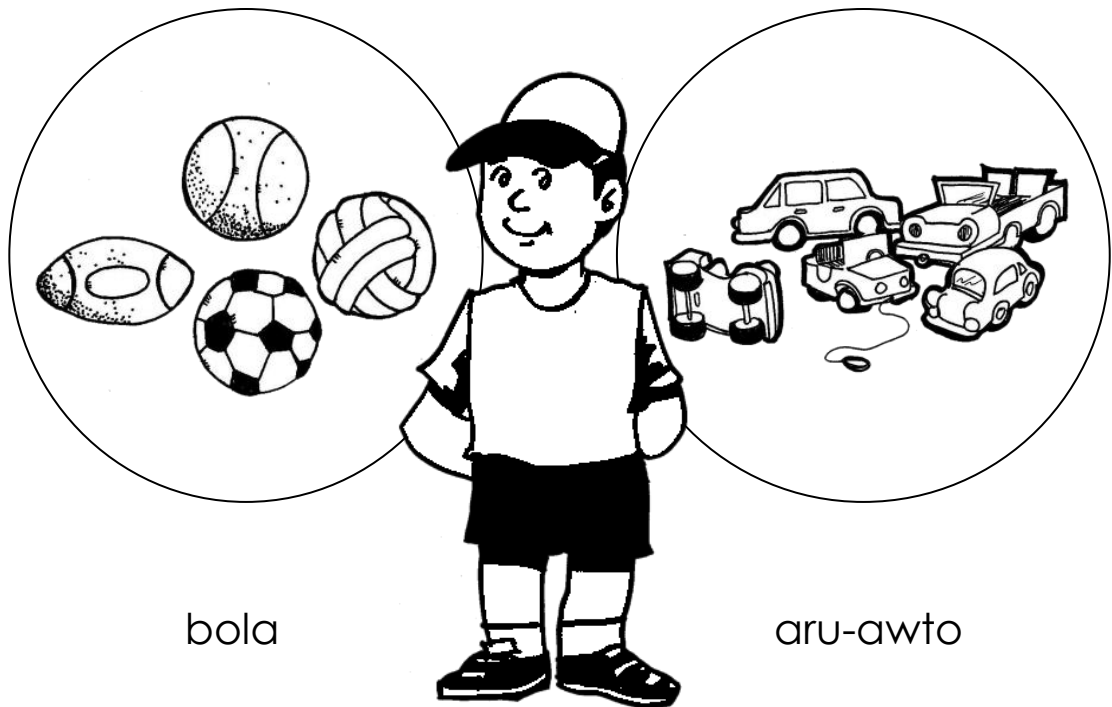

Buruhaton 1: Ano an numero nga sobra han hinatag nga numero? Pilia an eksakto nga baton.

- 1. 6 (7 8 9)
- 2. 27 (26 28 29)
- 3. 42 (45 44 43)
- 4. 51 (52 53 55)
- 5. 74 (71 73 75)

Buruhaton 2: Igsurat an eksakto nga baton ha imo notebook.

- 1. 1 sobra ha 17 in _____.
- 2. 1 sobra ha in _____.
- 3. 1 sobra ha 66 in _____.
- 4. Usa sobra ha 71 in _____.
- 5. Usa sobra ha 97 in _____.

Buruhaton 3: Igsurat an eksakto nga baton ha imo papel.

1. Ano nga numero an usa sobra ha 18? _____
2. Ano nga numero an usa sobra ha 45? _____
3. Ano nga numero an usa sobra ha 79? _____
4. An 84 amo an usa sobra hin ano nga numero? _____
5. An 92 amo an usa sobra hin ano nga numero? _____

Buruhaton nga Pag-aradman ha Balay: Igsurat an eksakto nga baton ha imo **notebook**.

1. An 7 amo an usa sobra ha _____.
2. An 15 amo an usa sobra ha _____.
3. An _____ amo an usa sobra ha 99.
4. An _____ amo an usa sobra ha 53.
5. An _____ amo an usa sobra ha 81.

Iban hin Usa

Pagpahinumdom:

May ada 2 ka grupo hin panapton hi Luchie.
Guruguti an iya saya kontra han blusa. Eksakto ba hi Luchie? Paunan-o mo nahibaroan?



saya

blusa

An saya 3 ngan an blusa 4. An tulo guruguti hin usa ha upat.
Eksakto ba hi Luchie?

May usa nga blusa nga waray kapadis. Karuyag sidngon an kadamo han saya guruguti hin usa kontra han blusa. An tulo guruguti hin usa ha upat. Salit eksakto hi Luchie.

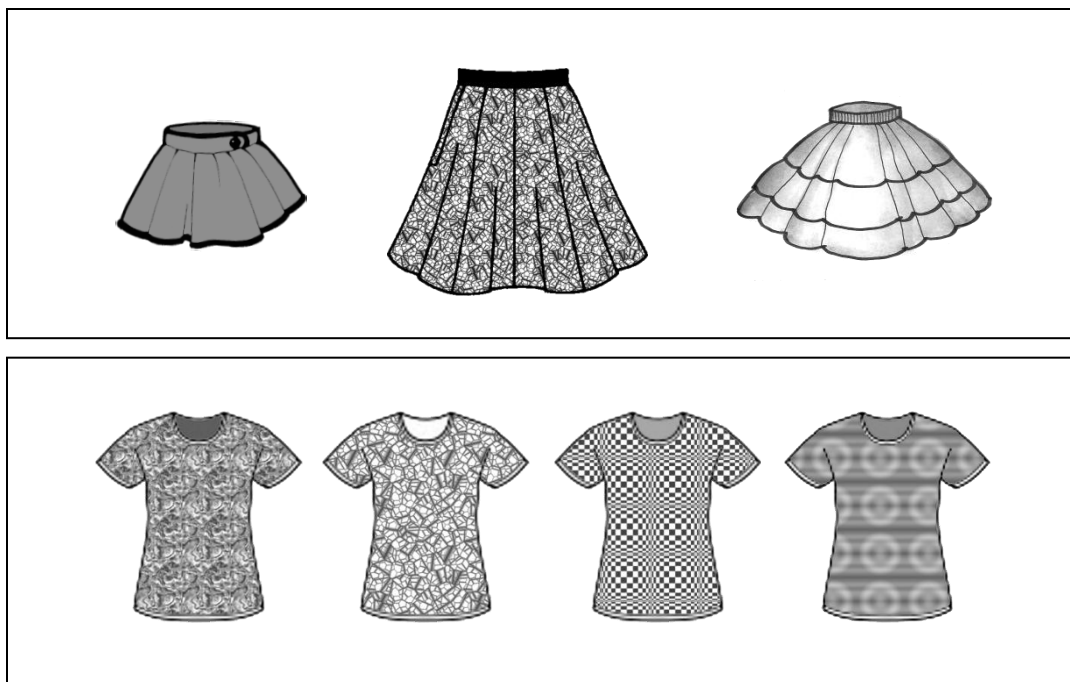

Para magkaada hin 3 nga **stick** kukuhaan naton hin usa ha 4 ka **stick**. An 3 guruguti hin usa ha 4. An karuyag sidngon guruguti an saya kontra han blusa. Salit, eksakto hi Luchie.

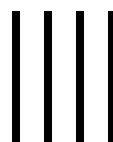

Kadamo han mga saya

Kadamo han blusa

Buruhaton 1: Ano an usa nga guruguti han hinatag nga numero? Pilia an eksakto nga baton.

1.  A. 22 B. 23 C. 25
2.  A. 36 B. 34 C. 33
3.  A. 61 B. 62 C. 64
4.  A. 71 B. 72 C. 74
5.  A. 99 B. 97 C. 96

Buruhaton 2: Igsurat an nawawara nga numero ha imo **notebook**.

1. An 1 guruguti hin 25 amo an_____.
2. An 1 guruguti hin 31 amo an _____.
3. An 1 guruguti hin 47 amo an _____.
4. An usa guruguti hin 76 amo an _____.
5. An usa guruguti hin 100 amo an _____.

Buruhaton 3: Igsurat an imo baton ha imo papel.

1. Ano nga numero an guruguti hin usa kontra han 15? _____
2. Ano nga numero an guruguti hin usa kontra han 33? _____
3. Ano nga numero an guruguti hin usa kontra han 54? _____
4. An 99 guruguti hin usa kontra hin ano nga numero? _____
5. An 46 guruguti hin usa kontra hin ano nga numero? _____

Balay Pag-aradman : Igsurat an letra han eksakto nga baton ha imo **notebook**.

- | | | | |
|-----------------------|-------|-------|-------|
| 1. an 3 guruguti han | A. 6 | B.5 | C. 4 |
| 2. an 16 guruguti han | A. 15 | B. 17 | C. 18 |
| 3. an 29 guruguti han | A. 27 | B. 28 | C. 30 |
| 4. an 35 guruguti han | A. 38 | B. 36 | C. 34 |
| 5. an 50 guruguti han | A. 53 | B. 51 | C. 49 |

“Guruguti ngan Darudamo”

Pagpahinumdom:

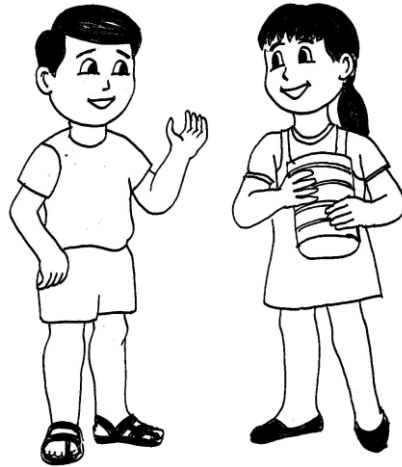



Asya ini hira Bob ngan Ann.

Hi Ann nagkuha hin 6 nga gumamela nga pula.

Hi Bob nagkuha hin 8 nga gumamela nga dulaw.

Hin-o an may ada darudamo nga gumamela?

Hin-o an may ada guruguti nga gumamela?

Ann	
Bob	

Hin-o an mga bata ha aton istorya?

Ano an ginkuha han kada usa?

Pira nga gumamela an ginkuha ni Ann?

Pira man an kan Bob?

Hin-o an may ada darudamo an ginkuha? Pira man an diperensiya?

Buruhaton 1: Pagkumparaha an duha ka grupo.
 Kopyaha ha iyo **notebook** an grupo nga may darudamo nga butang.

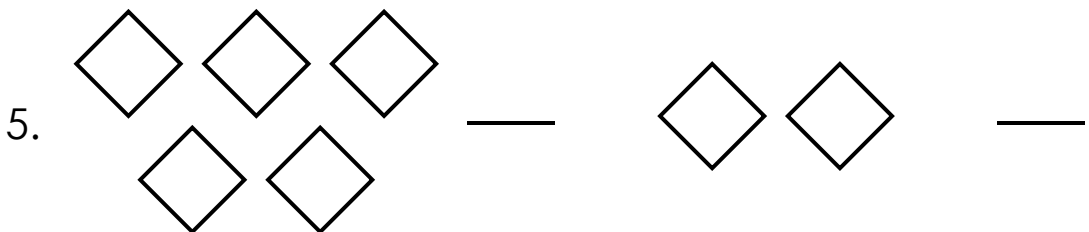
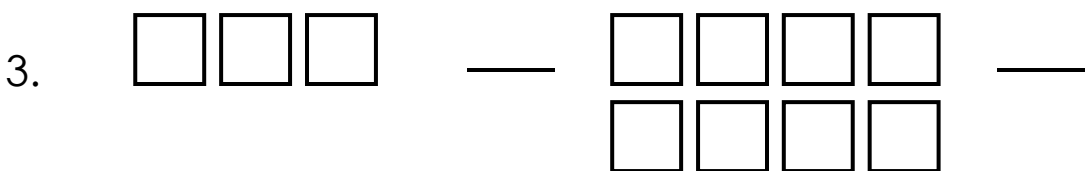
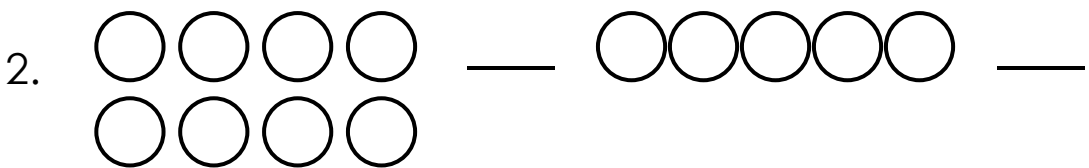
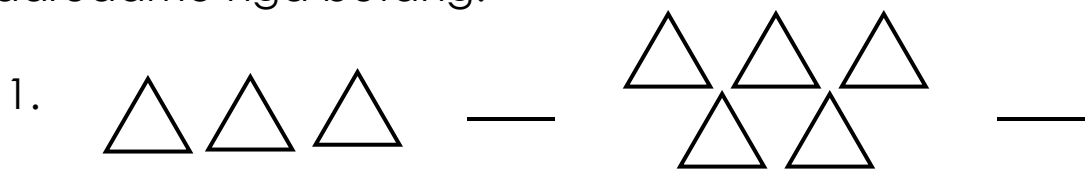

Buruhaton 2: Pagkumparaha an duha ka grupo.
Kopyaha ha iyo papel an grupo nga may guruguti
nga butang.

1.

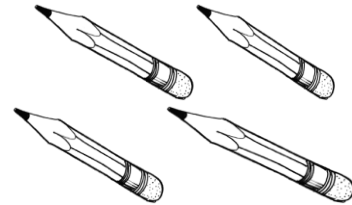
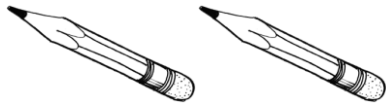

2.



3.

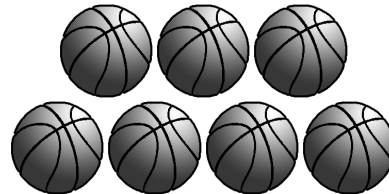
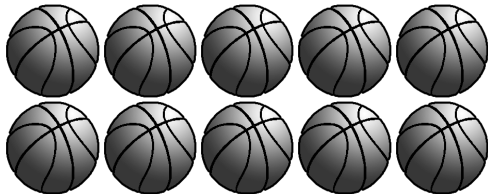







4.

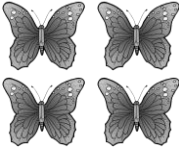

5.

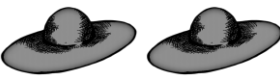
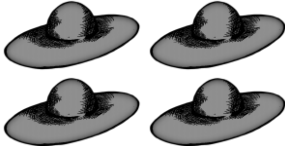
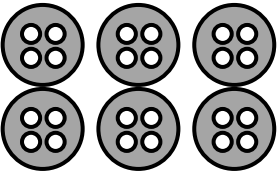

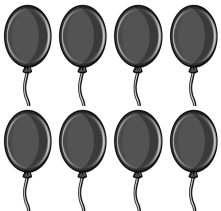
Buruhaton 3: Pagtandinga an duha nga grupo. Pilia an eksakto nga pulong.

1.  (guruguti, darudamo) kontra han 
2.  (guruguti, darudamo) kontra han 
3.  (guruguti, darudamo) kontra han 
4.  (guruguti, darudamo) kontra han 
5.  (guruguti, darudamo) kontra han 

Balay Pag-aradman

Pagdrowing ha iyo **notebook** hin guruguti nga butang kontra han hinatag nga grupo.

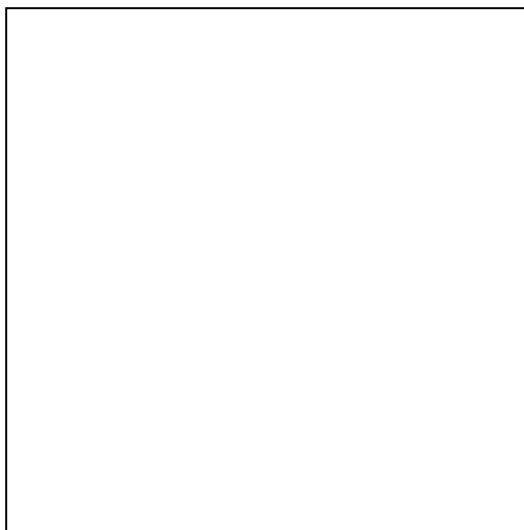
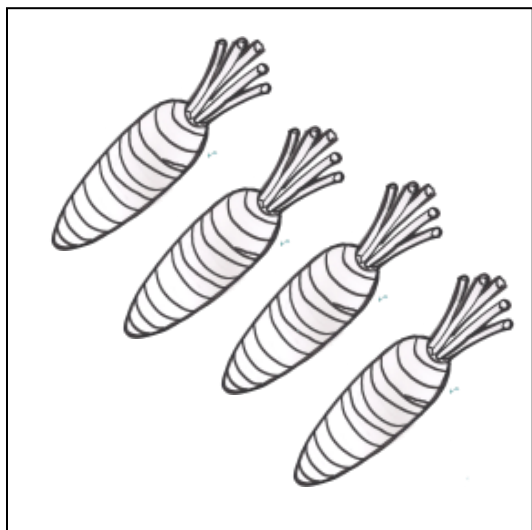

Pagdrowing ha iyo **notebook** hin darudamo nga butang kontra han hinatag nga grupo.

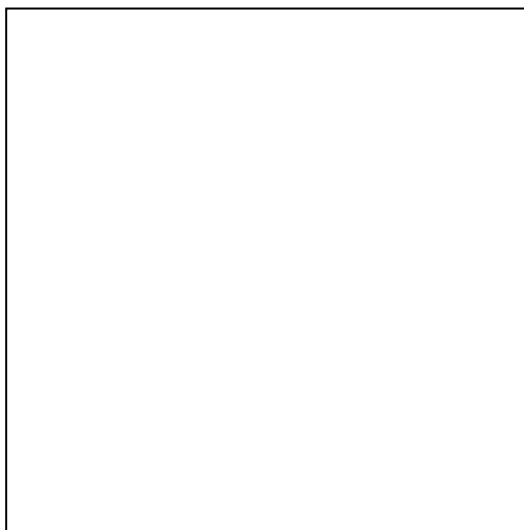
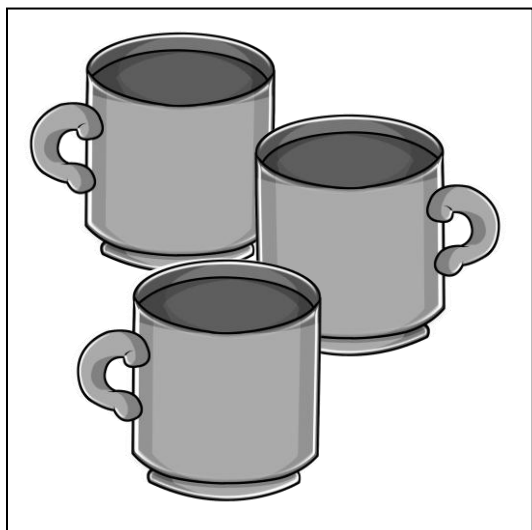

“Pareho Kadamo Han”

Pagpahinumdon:

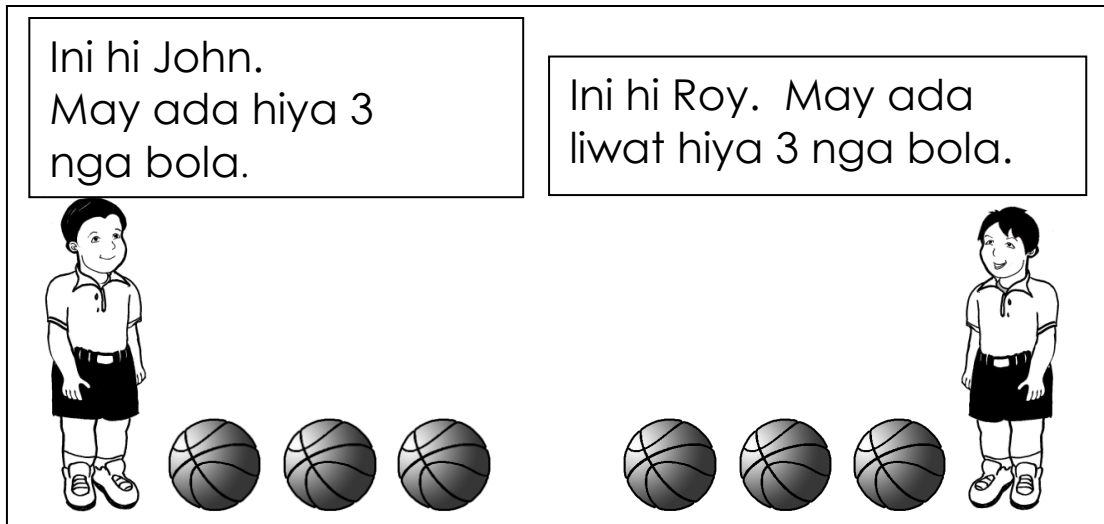

Bola ni John



Set A



Bola ni Roy







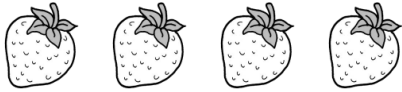

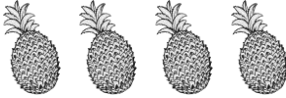
Set B



Pareho kadamo an bola nira John ngan Roy. Masiring kita nga pareho an mga butang ha **Set A** ngan **Set B**. Kun aton igtatanding an duha nga **Set** nga pareho hin kadamo an mga butang, mahihibaro kita han ekspresyon nga “pareho kadamo han”.

Buruhaton 1: Pilia an letra nga may parehas nga kadamo hin butang nga iginpakita .

1. 	
a. 	b. 

2. 	
a. 	b. 

3. 	
a. 	b. 

4. 	
a. 	b. 

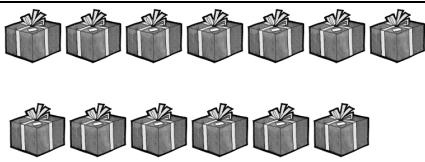
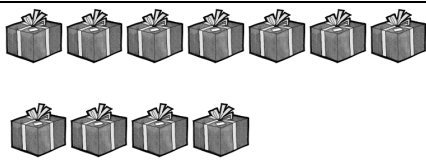
5. 	
a. 	b. 

Buruhaton 2: Pagpadisa an mga grupo nga pareho kadamo an mga butang. Igsurat ha iyo papel an letra han eksakto nga baton

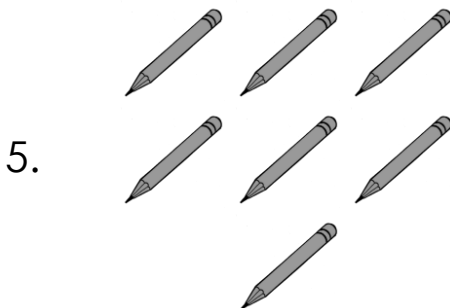

A

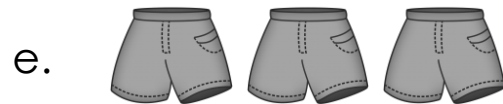
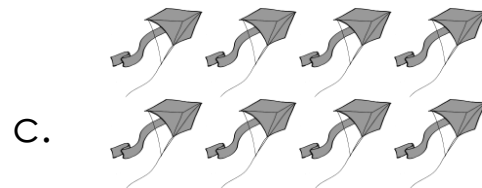

B

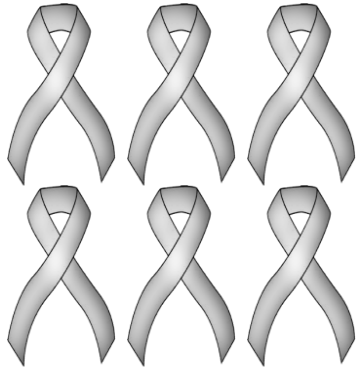

Balay Pag-aradman : Pagdrowing ha iyo **notebook** hin mga butang parehas kadamo han iginpakita han grupo ha wala.

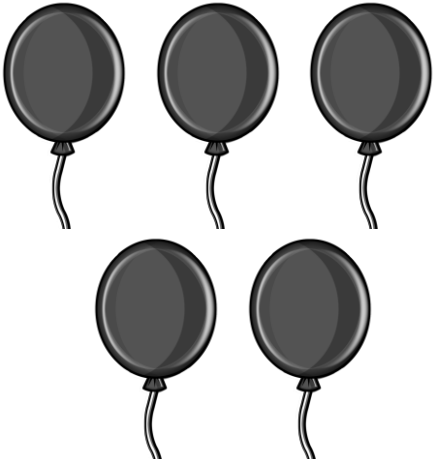
1.		
2.		
3.		

Pagsusunod-sunod Tikang ha Gutia y Tikadako o Tikang ha Dako Tikagutia y nga Numero han mga Butang

Pagpahinumdom:

Pumakadto ha tindahan hin mga libro hi Mark para pumalit hin lapis. Pinmalit hiya hin 3 nga busag nga lapis, 5 nga pula nga lapis, ngan 1 nga dulaw nga lapis. Igsurat an ngatanan nga imo naobserbahan.

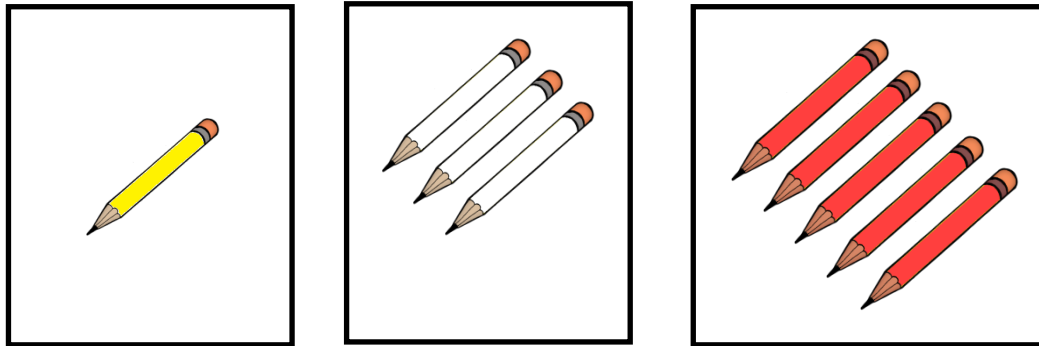

Pagsunod-sunura an kadamo han lapis tikang gutia y ngadto tikadako

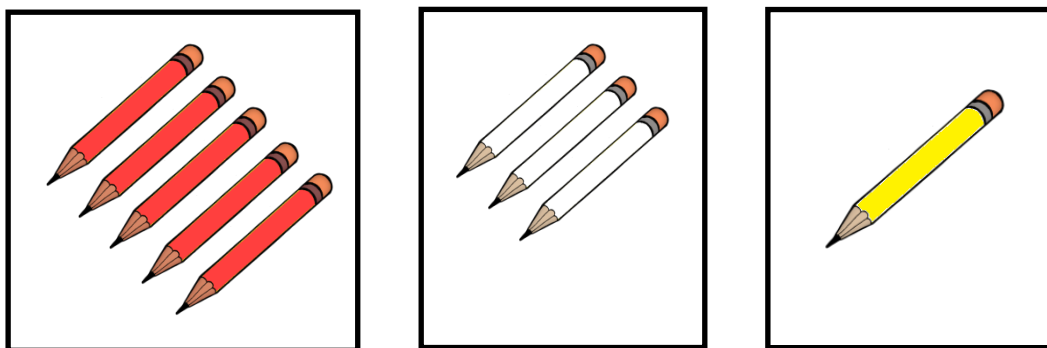

Pagsunod-sunura an kadamo tikang dako ngadto tipagutia y

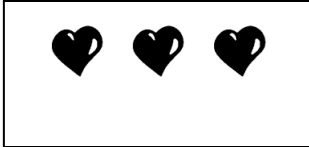

Buruhaton 1: Pagsunod-sunura an mga grupo. Igsurat an eksakto nga mga letra ha iyo **notebook**.

1.   

A B C

Gutiay tikadako: _____, _____, _____

Dako tikagutiay: _____, _____, _____

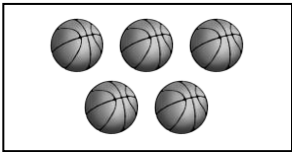
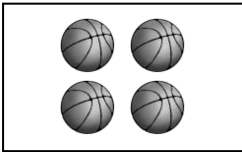
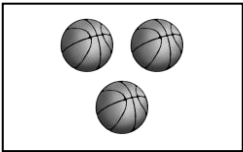
2.   

A B C

Gutiay tikadako: _____, _____, _____

Dako tikagutiay: _____, _____, _____

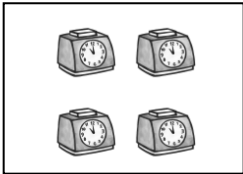
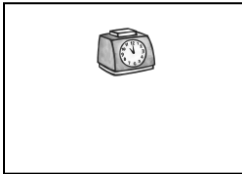
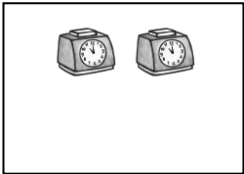
3.   

A B C

Gutiay tikadako: _____, _____, _____

Dako tikagutiay: _____, _____, _____

4.

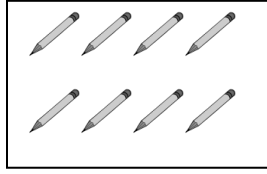

A

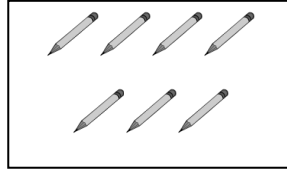

B

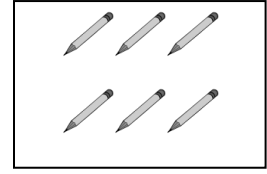

C

Gutia'y tikadako: _____, _____, _____

Dako tikagutia'y: _____, _____, _____

5.

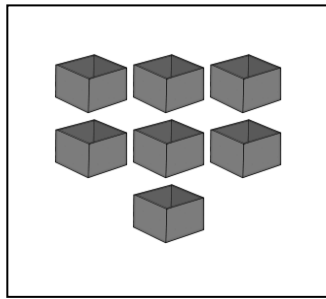

A

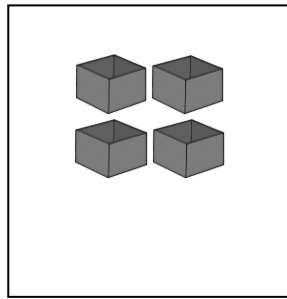

B

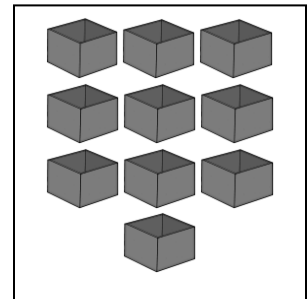

C

Gutia'y tikadako: _____, _____, _____

Dako tikagutia'y: _____, _____, _____

Paypay han Buruhaton 2:

A. Pagdrowing hin mga butang ha iyo papel base maipakita an "dako tipagutia'y".

1.

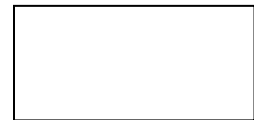
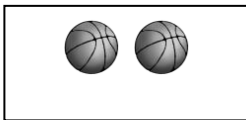
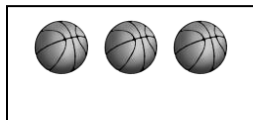

2.

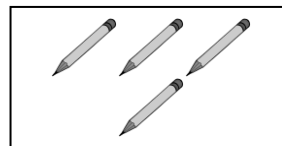
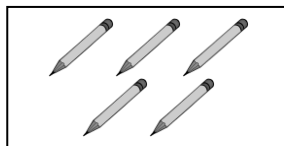

3.

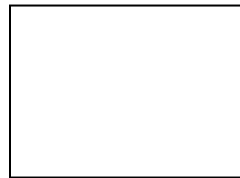
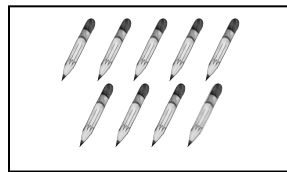
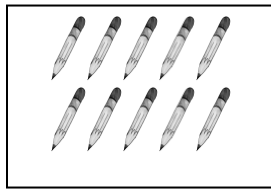

B. Pagdrowing hin mga butang ha iyo papel base maipakita an “gutiay tikadako”.

1.

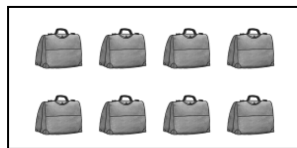

2.

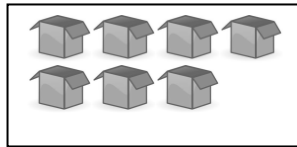
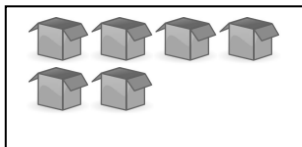

Balay Pag-aradman: Drowinga an grupo hin mga butang ha iyo **notebook**. Butangi hin tsek (✓) an grupo nga may ada Gutiay nga mga butang ngan butangi hin ekis (x) an grupo nga damo an mga butang.

1.

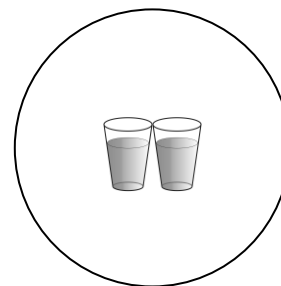
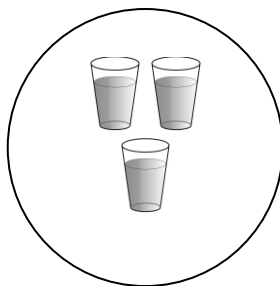
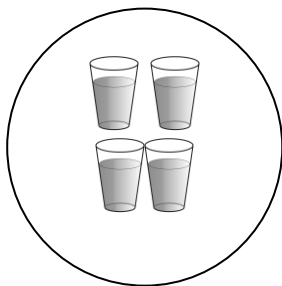

2.

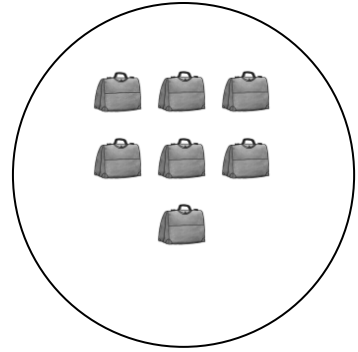
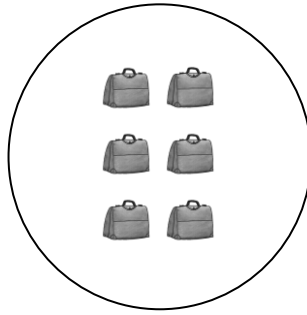
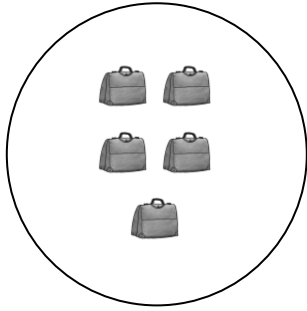

3.

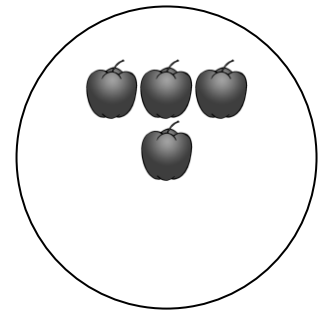
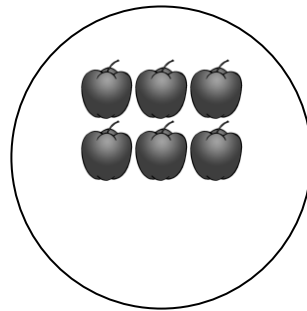
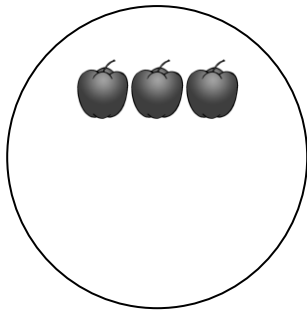

4.

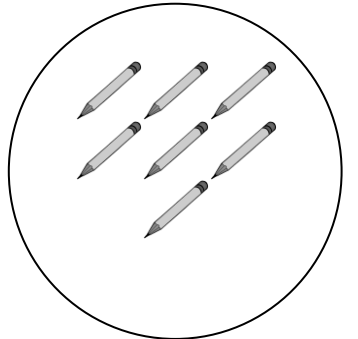
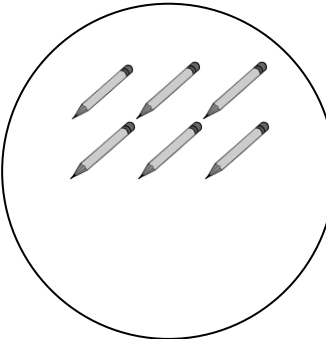
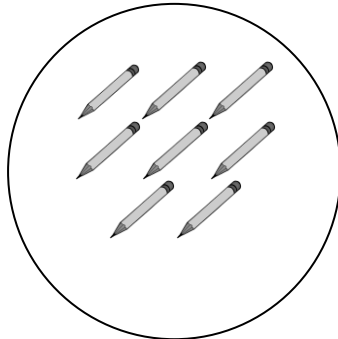

5.

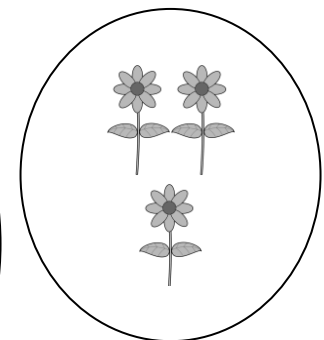
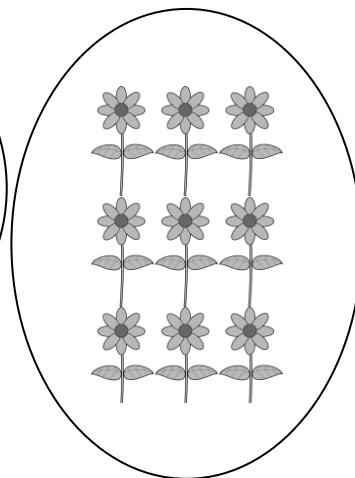
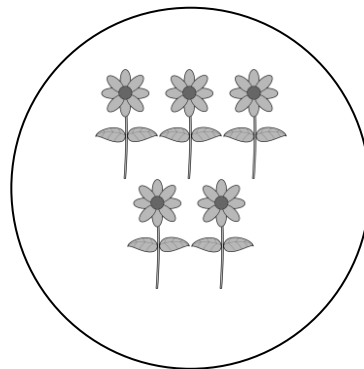

Pagtanding hin mga Numero Kutob Usa ka Gatos Gamit an mga Simbolo

Pagpahinumdom:

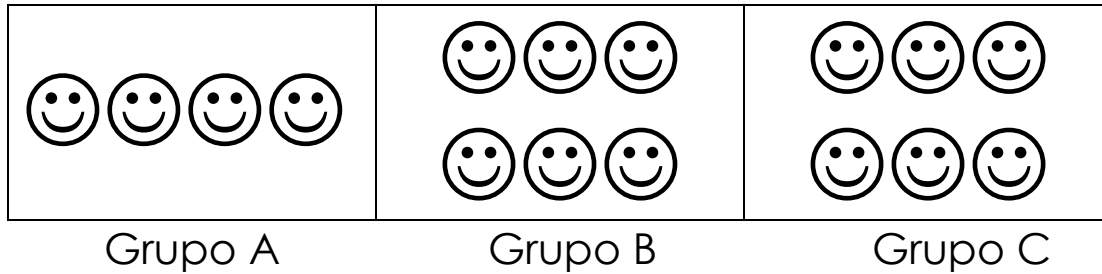

Kitaa an tulo nga grupo ha igbaw. Pagsumat han imo mga naobserbaran.

Guruguti an mga bata ☺ ha Grupo A kontra ☺ ha Grupo B.

Guruguti an mga bata ☺ ha Grupo A kontra ☺ ha Grupo C.

Darudamo an ☺ ha Grupo B kontra ☺ ha Grupo A.

Darudamo an ☺ ha Grupo B kontra ☺ ha Grupo A.

Magpareho an kadamo ☺ han Grupo B ☺ ngan Grupo C.

Buruhaton 1:

Kumpletohan blangko nga linya hin:

a. Darudamo han, guruguti han o parehas la

b. >, <, o =

1. a. 35 _____ 25

b. 35 _____ 25

2. a. 88 _____ 89

b. 88 _____ 89

3. a. 67 _____ 67

b. 67 _____ 67

4. a. 41 _____ 31

b. 41 _____ 31

5. a. 55 _____ 55

b. 55 _____ 55

Buruhaton 2: Kopyaha an eksakto nga numero ha iyo papel.

1. An 28 darudako kontra han (18, 38) _____
2. An 15 guruguti kontra han (45, 5) _____
3. An 88 parehas la ha (77, 88) _____
4. An 54 parehas la ha (54, 64) _____
5. An 90 guruguti han (91, 90) _____

Buruhaton 3: Pilia an numero nga diri kaapi ha grupo.

- | | | | |
|----------------------|----|----|----|
| 1. Darudako han 24 | 21 | 23 | 25 |
| 2. Guruguti han 81 | 81 | 80 | 84 |
| 3. Parehas la han 35 | 30 | 37 | 35 |
| 4. Darudako han 15 | 18 | 15 | 14 |
| 5. Guruguti han 72 | 70 | 72 | 74 |

Balay Pag-aradman. Batona an mga masunod ha iyo **notebook**.

1. Igsurat an numero nga darudako han
 - a. 4
 - b. 7

2. Igsurat an numero nga guruguti han
 - a. 10
 - b. 8
 - c. 5

3. Pagsurat hin usa nga numero nga guruguti han 12 pero darudako han 5.

4. Pagsurat hin usa nga numero nga darudako han 47 pero guruguti han 80.

Pagsunod-sunod hin mga Numero

Pagpahinumdom:

Kitaa an mga grupo han mga kendi.

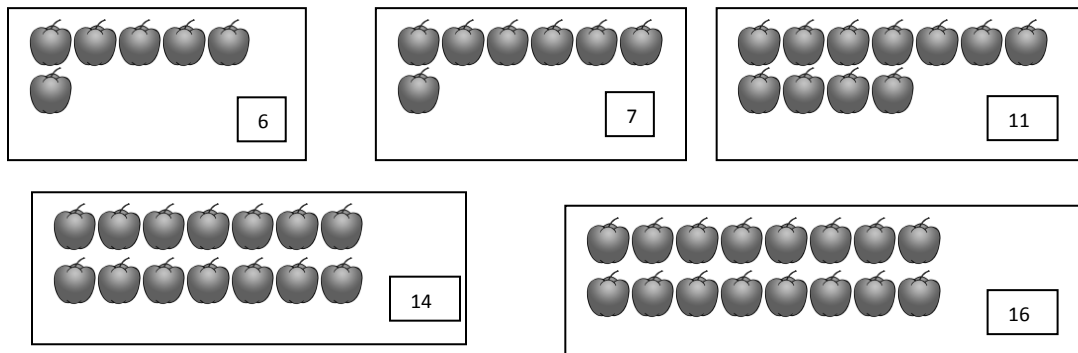

An numero han kada grupo hin kendi in:

6 7 11 14 16

Ini nga mga numero ginsunod-sunod ha **tipadamo nga paagi**

Kitaa an grupo hin mga bituon.



An numero han mga bituon ha kada grupo in:

47 44 30 16

Ini nga mga numero ginsunod-sunod ha **tikagutiay nga paagi**.

Buruhaton 1: Pagsunod-sunura an mga butang ha tikadamo nga paagi. Igsurat an eksakto nga letra ha imo **notebook**.

<div style="text-align: right; border: 1px solid black; padding: 2px; width: fit-content; margin: 0 auto;">Set A</div>	<div style="text-align: right; border: 1px solid black; padding: 2px; width: fit-content; margin: 0 auto;">Set B</div>
<div style="text-align: right; border: 1px solid black; padding: 2px; width: fit-content; margin: 0 auto;">Set C</div>	<div style="text-align: right; border: 1px solid black; padding: 2px; width: fit-content; margin: 0 auto;">Set D</div>
<div style="text-align: right; border: 1px solid black; padding: 2px; width: fit-content; margin: 0 auto;">Set E</div>	<div style="text-align: right; border: 1px solid black; padding: 2px; width: fit-content; margin: 0 auto;">Set F</div>



Buruhaton 2: Pagsunod-sunura an mga numero ha tipadamo nga paagi. Igsurat an eksakto nga baton ha imo papel

- | | | | | | |
|----|-------|-------|-------|-------|-------|
| 1. | 14 | 26 | 84 | 72 | 35 |
| | _____ | _____ | _____ | _____ | _____ |
| 2. | 98 | 43 | 11 | 29 | 57 |
| | _____ | _____ | _____ | _____ | _____ |
| 3. | 9 | 28 | 75 | 4 | 64 |
| | _____ | _____ | _____ | _____ | _____ |
| 4. | 88 | 36 | 21 | 5 | 17 |
| | _____ | _____ | _____ | _____ | _____ |

Buruhaton 3: Kopyaha an mga numero ha imo papel. Butangi an blangko nga linya hin numero para masunod- sunod ha tikadamo nga paagi.

- | | | | | | |
|----|-------|-------|-------|-------|-------|
| 1. | 24 | 36 | 56 | _____ | 75 |
| 2. | 6 | _____ | 27 | 34 | 67 |
| 3. | 15 | 20 | _____ | _____ | 54 |
| 4. | _____ | 25 | 45 | 52 | _____ |
| 5. | 22 | _____ | 36 | _____ | 98 |

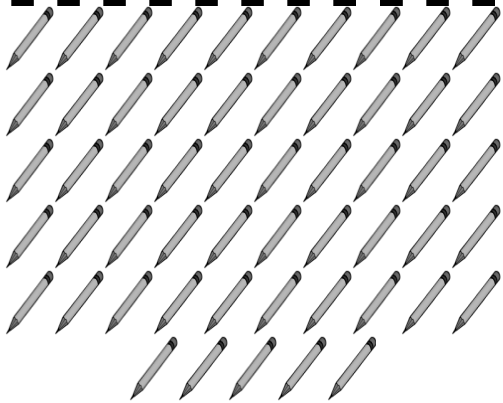
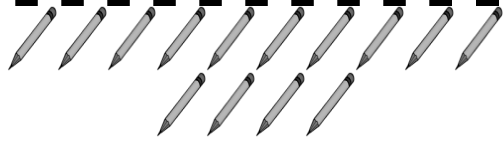
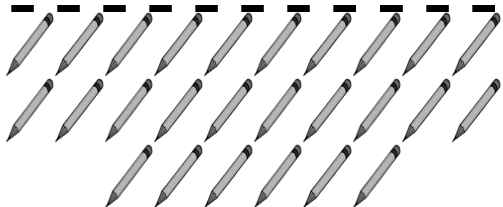
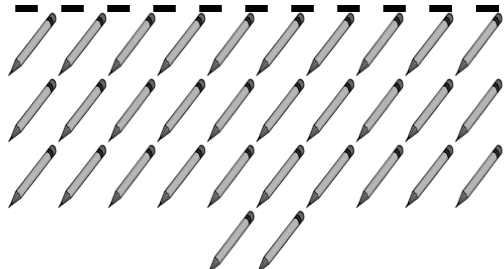
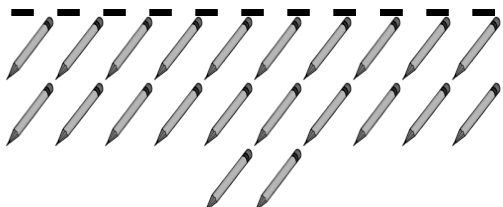
Buruhaton 4: Pagsunod-sunura an mga butang ha tikagutiay nga paagi. Isurat an eksakto nga letra ha imo **notebook**.

	
Set A	Set B
	
Set C	Set D
	
Set E	Set F

Buruhaton 5: Pagsunod-sunora an mga numero ha tikagutiay nga paagi. Isurat an imo baton ha imo **notebook**.

1. 24 16 72 42 64
 2. $\frac{\quad}{89}$ $\frac{\quad}{34}$ $\frac{\quad}{11}$ $\frac{\quad}{39}$ $\frac{\quad}{47}$
 3. $\frac{\quad}{10}$ $\frac{\quad}{28}$ $\frac{\quad}{25}$ $\frac{\quad}{14}$ $\frac{\quad}{36}$
 4. $\frac{\quad}{66}$ $\frac{\quad}{37}$ $\frac{\quad}{51}$ $\frac{\quad}{9}$ $\frac{\quad}{47}$
- _____

Buruhaton 6: Kopyaha an mga numero ha imo **notebook**. Butangi an blangko nga linya hin numero para masunod-sunod ha tipagutiay nga paagi.

1. 44 36 25 _____ 15
2. 76 _____ 48 34 17
3. 85 70 _____ _____ 46
4. _____ 65 54 47 _____
5. 78 _____ _____ _____ 98

Laktaw nga Pag-ihap hin Tag 2

Pagpahinumdom:

Tikang ha 2, makukuha naton an masunod nga numero kun malaktaw kita hin tagduha ha pag-ihap.

2, 4, 6, 8, 10, 12, 14, 16, 18, 20,
22, 24, 26, 28, 30, 32, 34, 36,
38, 40, 42, 44, 46, 48, 50, 52,
54, 56, 58, 60, 62, 64, 66, 68,
70, 72, 74, 76, 78, 80, 82, 84,
86, 88, 90, 92, 94, 96, 98, 100

Buruhaton 1: Kopyaha an mga numero ha imo papel. Isurat an imo baton ha blangko nga linya.

1. 2, 4, ____, 8, ____, 12
2. 12, 14, 16, ____, 20
3. ____, 34, 36, ____, 40
4. 52, ____, 56, ____, 60
5. 92, ____, 96, 98, ____

Buruhaton 2: Pira ngatanan? Igsurat an numero ha imo papel.

____ 1. 

____ 2. 

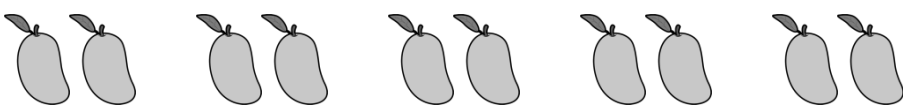
____ 3. 

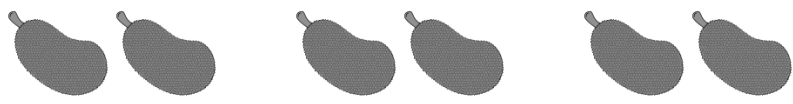
____ 4. 

____ 5. 

Balay Pag-aradman: Kopyaha an **table** ha imo **notebook**. Laktaw nga pag-ihap hin tag 2. Pagtikang ha 2 ngan lidongi an mga nasunod nga numero hasta 50.

1	2	3	4	5	6	7	8	9	10
11	12	13	14	15	16	17	18	19	20
21	22	23	24	25	26	27	28	29	30
31	32	33	34	35	36	37	38	39	40
41	42	43	44	45	46	47	48	49	50

Laktaw nga Pag-ihap hin Tag 5

Pagpahinumdom:

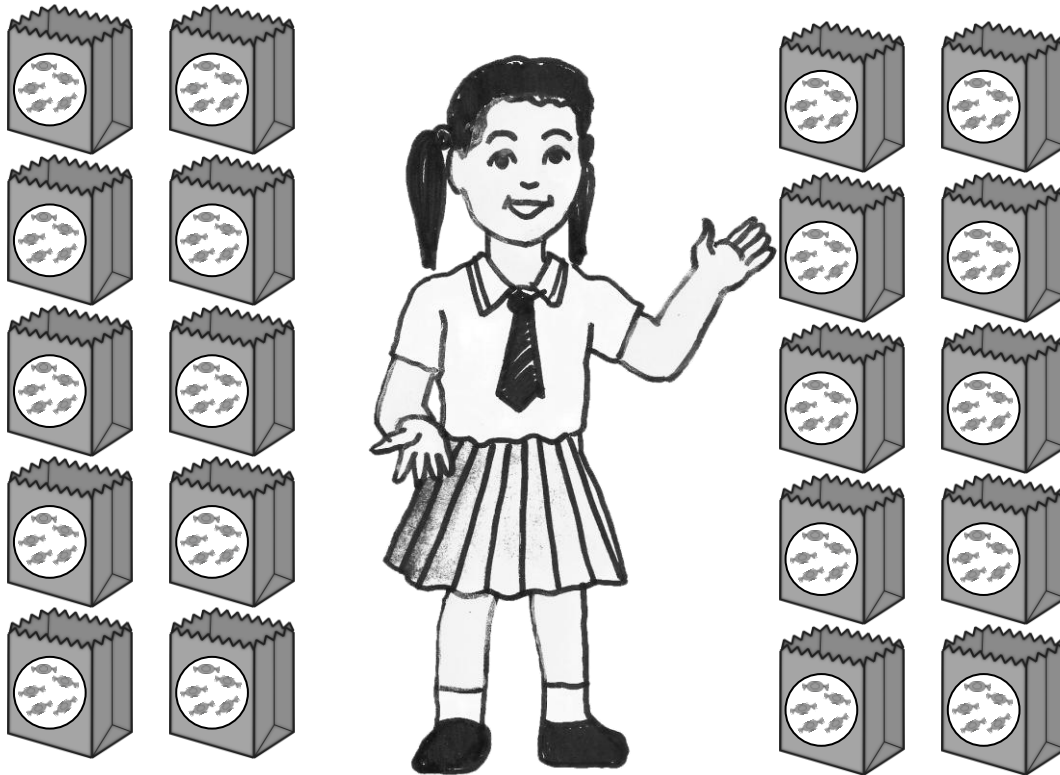

Mayda hi Ana 20 ka pakete hin mga kendi.
Kada pakete mayda 5 nga kendi.
Pira ngatanan nga kendi an iya kinanglan ibaligya?

Puydi kita paglaktaw hin 5 ha pag-ihap para makakuha hin baton. Nalaktaw kita pag-ihap hin 5 kon natikang kita hin numero ngan gindudugngan ta hin 5 pirmi nga magresulta hin pakakuha hin masunod nga numero.

Tikang ha 5, makukuha ta an mga masunod nga numero kon matikang kita hin laktaw nga pag-ihap hin tag 5 :

5	10
15	20
25	30
35	40
45	50
55	60
65	70
75	80
85	90
95	100

Sanglit, hi Ana dapat magbaligya ngatanan hin 100 nga kendi.

Para hin iba pa nga mga pananglitan, kon matikang kita hin 2, makakakuha kita han masunod nga mga numero kon maglaktaw kita pag-ihap hin tag 5.

2	7
12	17
22	27
32	37
42	47
52	57
62	67
72	77
82	87
92	97

Buruhaton 1: Laktaw nga pag-ihap hin tag lima.
 Butangi hin sakto nga baton an blangko nga linya.

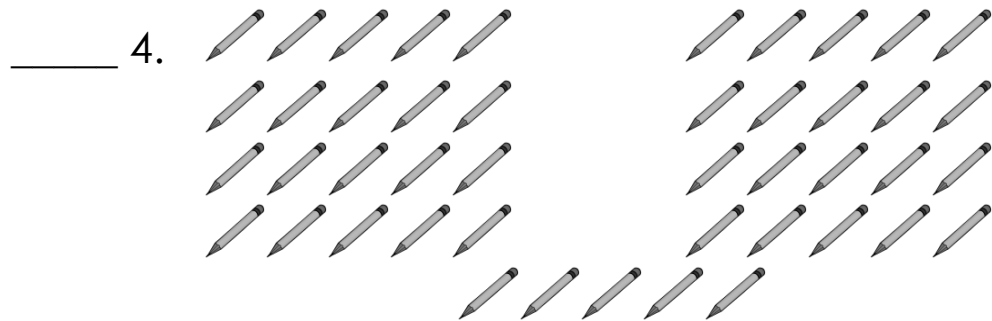
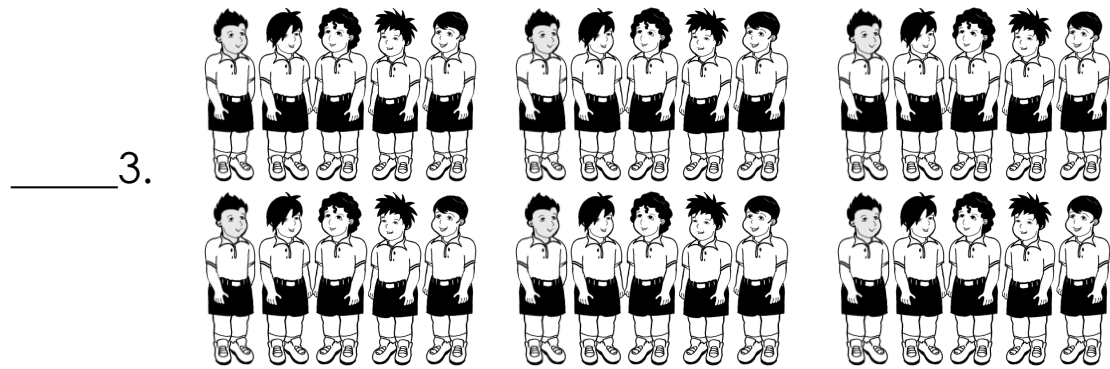
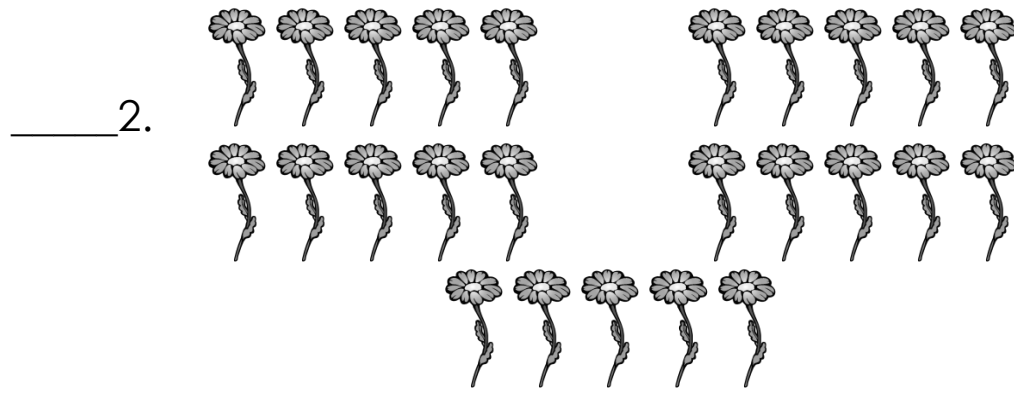
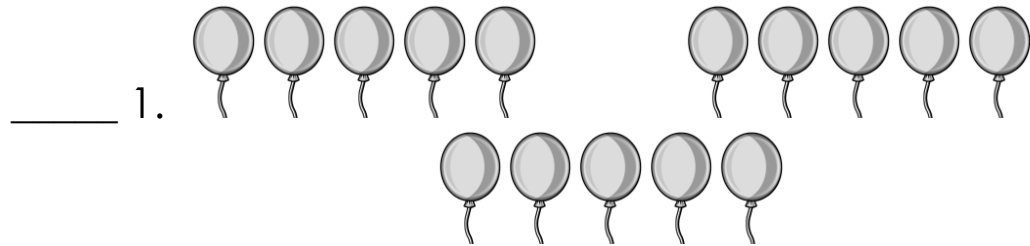

5.

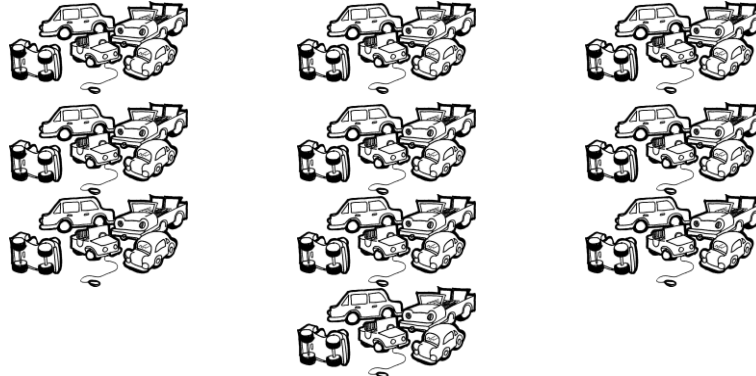

6.

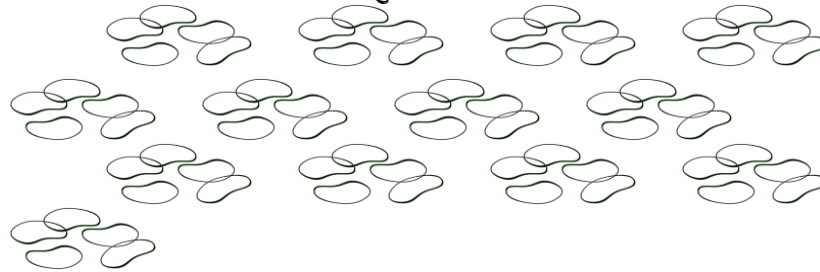

7.

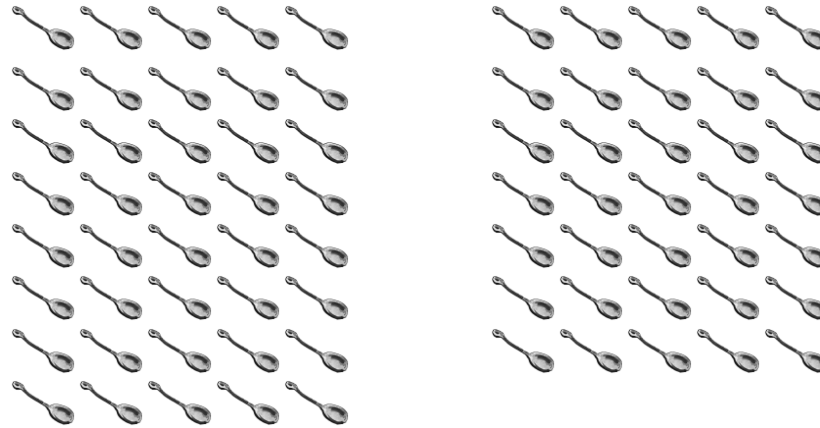

8.

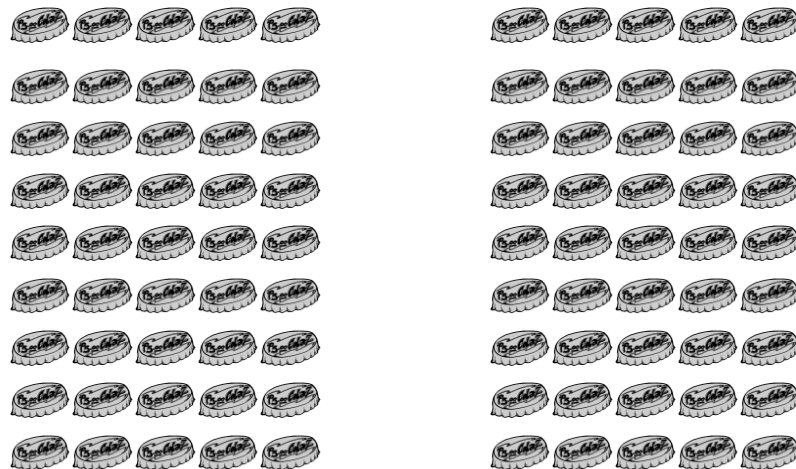

Buruhaton 2: Igsurat an mga nawawara nga numero ha imo **notebook**.

1. 5, 10, 15, ____, 25, 30
2. 1, 6, 11, 16, 21, ____
3. 55, ____, 65, 70, ____, ____
4. 24, 29, 34, ____, 44, ____
5. ____, 13, 18, 23, ____, 33

Buruhaton ha Balay:

- A. Kopyaha an **table** ha imo papel. Laktaw nga pag-ihap hin tag 5. Tikang ha 5 lidongi an masunod nga numero hasta 100.

1	2	3	4	5	6	7	8	9	10
11	12	13	14	15	16	17	18	19	20
21	22	23	24	25	26	27	28	29	30
31	32	33	34	35	36	37	38	39	40
41	42	43	44	45	46	47	48	49	50
51	52	53	54	55	56	57	58	59	60
61	62	63	64	65	66	67	68	69	70
71	72	73	74	75	76	77	78	79	80
81	82	83	84	85	86	87	88	89	90
91	92	93	94	95	96	97	98	99	100

- B. Tikang ha 6, Laktaw ma 5 ha pag-ihap hasta 100. Igsurat an mga numero ha imo papel.

Laktaw nga Pag-ihap hin Tag 10

Pagpahinumdom:

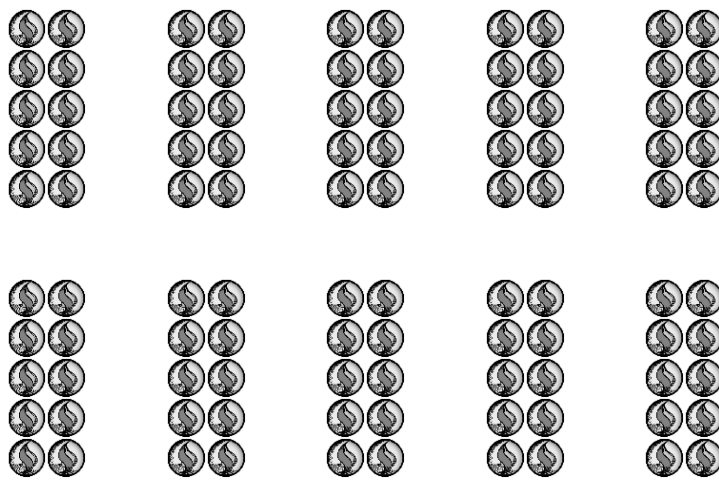

May ada 100 nga hollen hi John. Gingrupo ini niya hin tag-10. Pira an iya nahimo nga grupo?

May ada 10 nga grupo han 100 nga hollen. May ada 10 nga hollen ha kada grupo.

Kun malaktaw kita pag-ihap tikang hin 10 hasta 100, magdudugang kita hin 10 ha kada masunod nga numero ngan mapadayon pagdugang hin 10 hasta umabot hin 100.

Buruhaton 1: Igsering kun pira an may ada fig-10 ha kada **set**.

1.

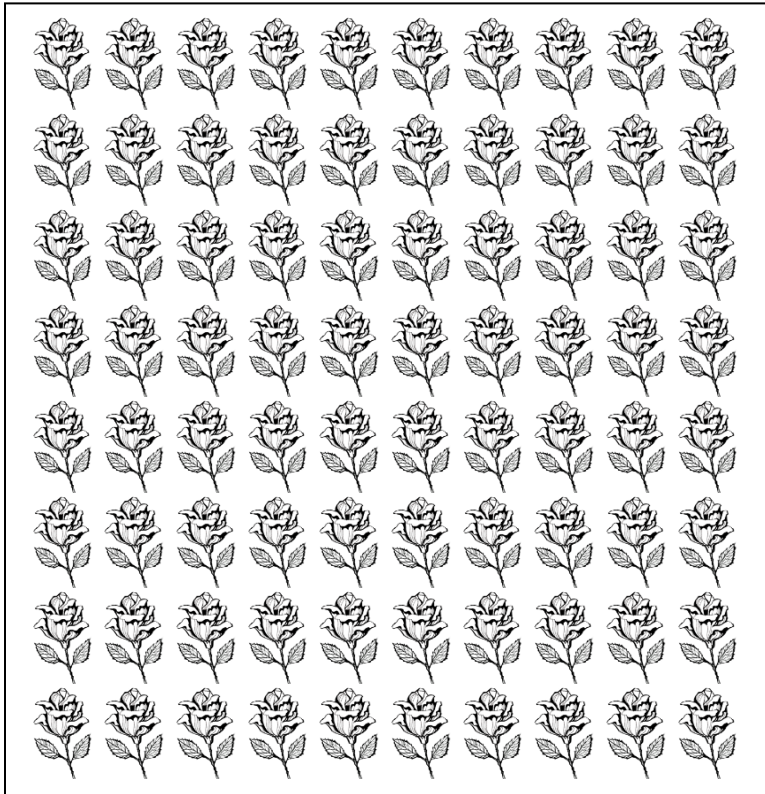

___ ka tag 10

2.

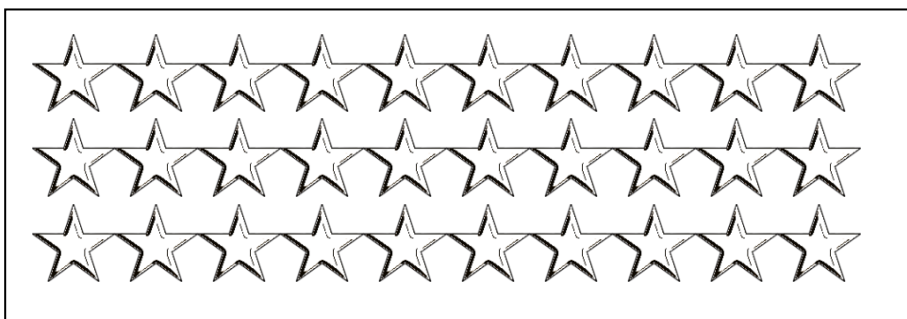

___ ka tag 10

3.

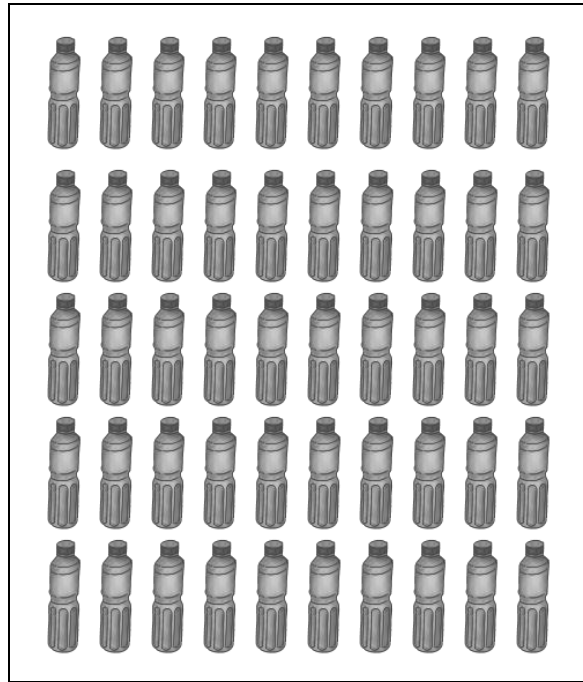

___ ka tag 10

4.

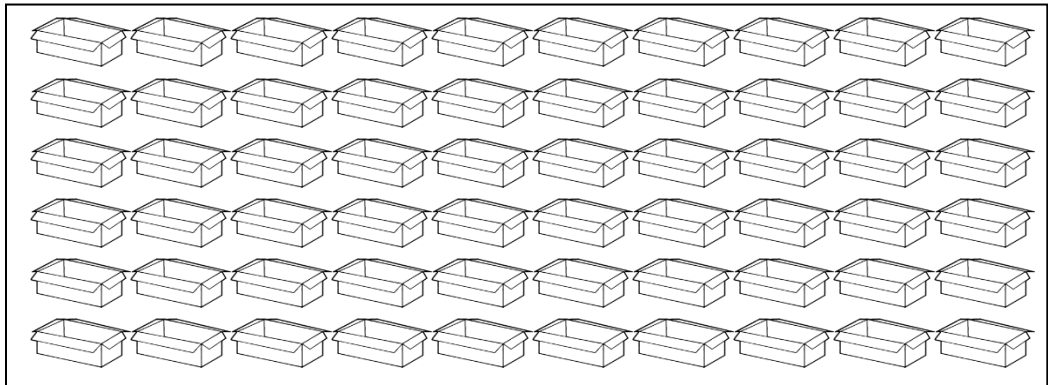

___ ka tag 10

5.

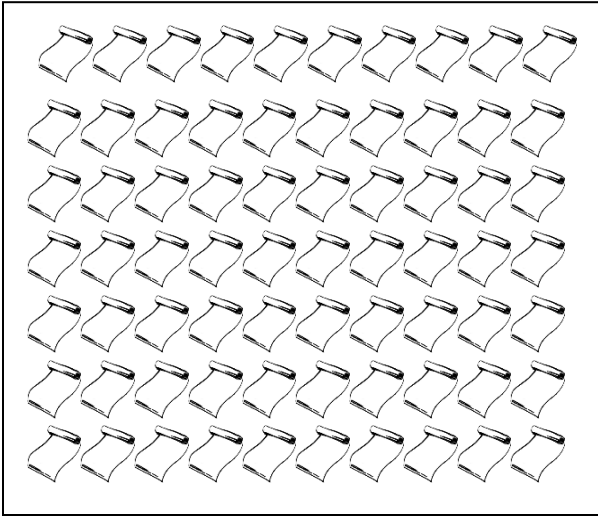

_____ ka tag 10

Buruhaton 2: Kopyaha an mga numero ha imo **notebook**. Igsurat an tutulo nga masunod nga numero ○ .

1. 20, 30, ○ ○ ○

2. 40, 50, ○ ○ ○

3. 10, 20, ○ ○ ○

4. 30, 40, ○ ○ ○

5. 50, 60, ○ ○ ○

Buruhaton 3: Kopyaha an drowing ha imo papel.
Laktaw ha pag-ihap hin tag 10. Igsurat an numero
ha .

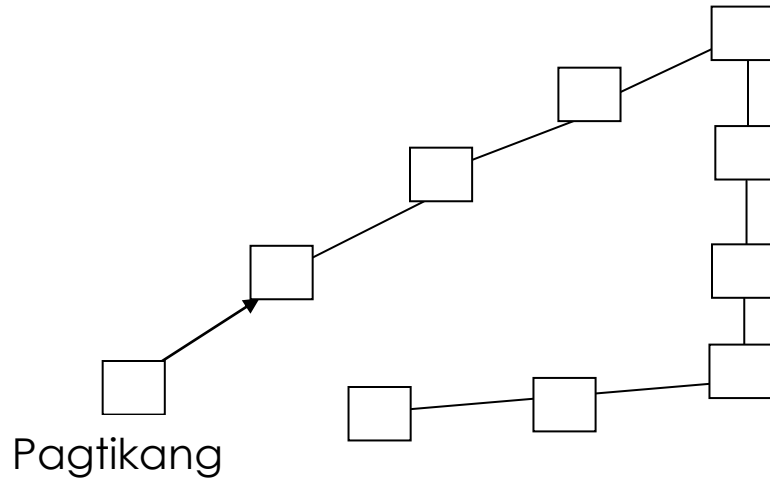

Balay Pag-aradman

Pagpadisa pinaagi hin linya an grupo A ngadto ha grupo B.

A

B

A. 50

a.

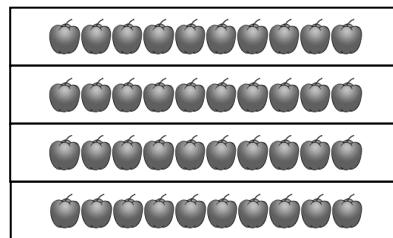

B. 10

b.

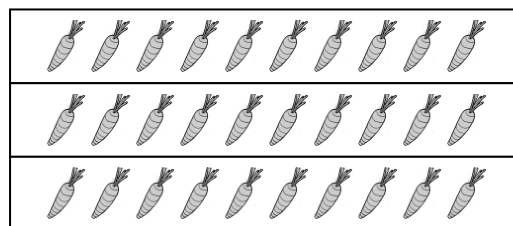

C. 30

c.



D. 20

d.

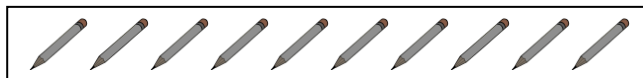

E. 40

e.

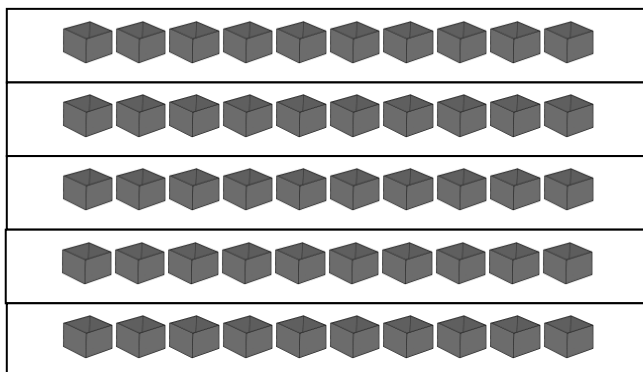

Pagbungkag ngan Pagtig-ub Hin mga Numero

Pagpahinumdom:

Kumusta! Ako hi Joey. May ada ako 8 nga holen. An iba hatag han akon tatay ngan an iba hatag liwat han akon nanay. Matitigo mo ba kon pira ngatanan an akon holen nga hatag han akon nanay ngan tatay?



Pira an holen nga hatag han tatay ni Joey?

Pira an holen nga hatag han nanay ni Joey?

Puydi an 8 nga holen:

7 nga holen tikang kan tatay ngan 1 nga holen tikang kan nanay o 8 an 7 ngan 1.

6 nga holen tikang kan tatay ngan 2 nga holen tikang kan nanay o 8 an 6 ngan 2.

5 nga holen tikang kan tatay ngan 3 nga holen tikang kan nanay o 8 an 5 ngan 3.

4 nga holen tikang kan tatay ngan 4 nga holen tikang kan nanay o 8 an 4 ngan 4.

3 nga holen tikang kan tatay ngan 5 nga holen tikang kan nanay o 8 an 3 ngan 5.

2 nga holen tikang kan tatay ngan 6 nga holen tikang kan nanay o 8 an 2ngan 6.

1 nga holen tikang kan tatay ngan 7 nga holen tikang kan nanay o 8 an 1 ngan 7.

8 nga holen tikang kan tatay ngan 0 nga holen tikang kan nanay o 8 an 8 ngan 0.

0 nga holen tikang kan tatay ngan 8 nga holen tikang kan nanay o 8 an 0 ngan 8.

Imo na ginpakita an mga paagi kun paunan-o an pagtimpo hin iba nga mga numero para makabug-os hin 8.

Kun gintagan hi Joey han iya tatay hin 10 nga holen ngan gintagan hiya hin 3 han iya nanay, pira ngatanan an holen ni Joey?

10 ngan 3 an 13.

Kun pagtampuhon an 10 ngan 3 mahihimo an 13.

Buruhaton 1: Hain ha duha nga numero an makakahimo hin sakto nga baton kun pagtimpuhon. Igsurat an letra nga baton ha imo **notebook**.

1. 9 an _____ A. 4 ngan 3 C. 7 ngan 2
B. 6 ngan 2 D. 8 ngan 3

2. 12 an _____ A. 7 ngan 3 C. 10 ngan 1
B. 9 ngan 2 D. 11 ngan 1

3. 18 an _____ A. 10 ngan 8 C. 8 ngan 8
B. 9 ngan 7 D. 6 ngan 7

4. 20 an _____ A. 2 ngan 0 B. 15 ngan 5
C. 10 ngan 2 D. 17 ngan 2

Buruhaton 2: Igsurat an nawawara nga numero ha imo papel.

1. 6 an 4 ngan _____.
2. 10 an _____ ngan 3.
3. 13 an 9 ngan _____.
4. 17 an _____ ngan 6.

Buruhaton 3: Igsurat an nawawara nga numero ha imo papel.

1. 5 an ___ ngan _____.
2. 14 an _____ ngan _____.
3. _____ an 1 ngan 5.
4. _____ an 7 ngan 4.
5. 9 an _____ ngan _____.

Buruhaton nga Pag-aradman ha Balay: Kopyaha an masunod ha imo **notebook**. Surati an mga blangko nga linya hin saktong baton.

1. 4 an _____ ngan _____.
2. 10 an _____ ngan _____.
3. 12 an _____ ngan _____.
4. 9 ngan 8 an _____.
5. 7 ngan 6 an _____.

Tag-usa ngan Tagnapulo

Pagpahanumdom:

Mayda 47 nga mga bituon.

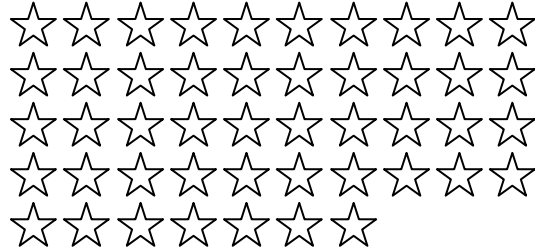

An mga bituon puydi magrupo ha tag 10 ha pagpakita nga mayda 4 ka tagnapulo ngan 7 katag-usa.

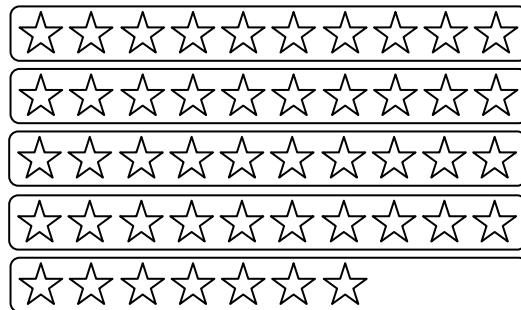

Mayda 4 ka tagnapulo ngan 7 nga tag-usa o 40 ngan 7.

Ha 47, an balyo han 4 amo an 4 ka tagnapulo o 40 samtang an balyo han 7 amo an 7 katag-usa o 7.

Salit ha tsart han Pwesto Kantidad (**Place Value Chart**), an 4 kinahanglan ibutang ha tagnapulo nga linya samtang an 7 kinahanglan ibutang ha tag-usa nga linya sugad han ipinapakita ha ubos.

Numero	Tagnapulo	Tag-usa
47	4	7

Buruhaton 1: Ihapa an mga butang ha kada grupo. Igsiring kun pira ka tagnapulo may ada ha kada numero.



Pipira nga mga tinidor tanan? _____
 Pipira ka grupo hin 10 tanan? _____

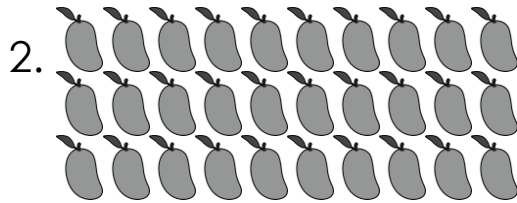

Pipira nga mga mangga tanan? _____
 Pipira ka grupo hin 10 tanan? _____



Pipira nga mga sudlay tanan? _____
 Pipira ka grupo hin 10 tanan? _____

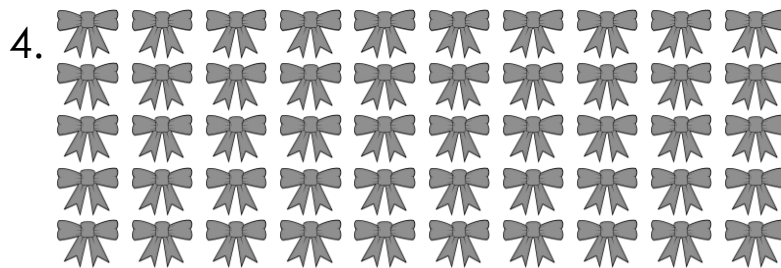

Pipira nga mga laso tanan? _____
 Pipira ka grupo hin 10 tanan? _____

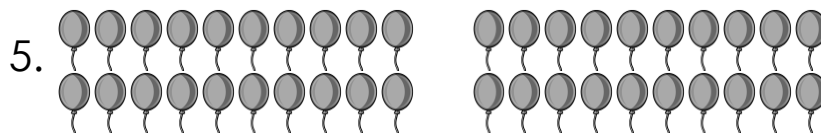

Pipira nga mga lobo tanan? _____
 Pipira ka grupo hin 10 tanan? _____

Buruhaton 2: Igdrowing an kadamo han grupo han mga butang ha iyo **notebook**.

1. 2 ka grupo nga may tag 10 nga dahon

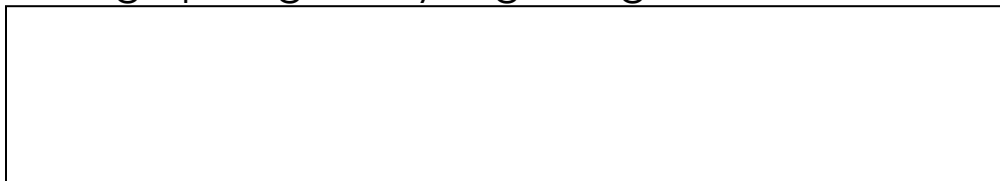

2. 3 ka grupo nga may tag 10 nga laso

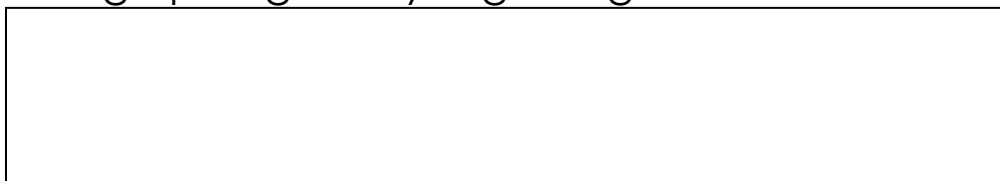

3. 4 ka grupo nga may tag 10 nga laso

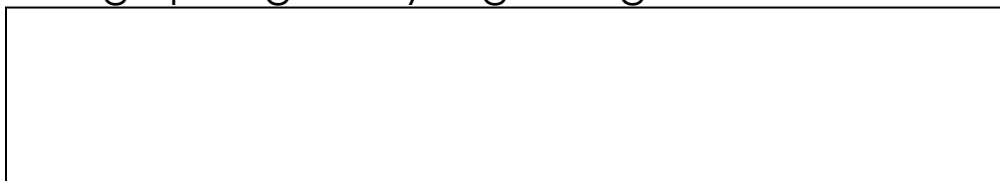

4. 3 ka grupo nga may tag 10 nga lapis

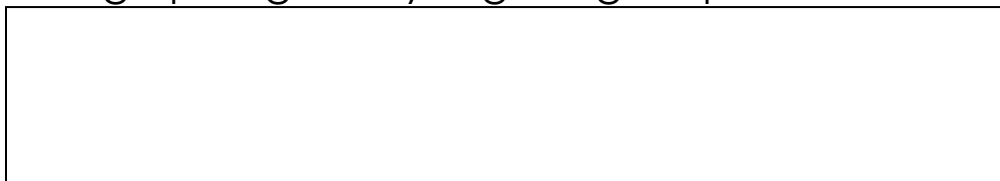

5. 5 ka grupo nga may tag 10 nga bola

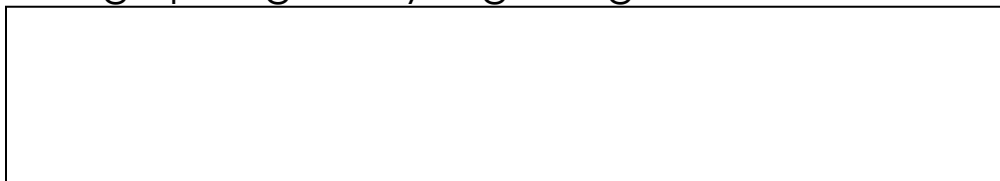

Worksheet 3:

A. Igsurat an eksakto nga baton ha imo papel.

1. in 7 ka tagnapulo ngan 9 nga tag-usa.
2. in 6 ka tagnapulo ngan 2 nga tag- usa.
3. in 8 ka tagnapulo ngan 5 nga tag-usa.
4. in 5 ka tagnapulo ngan 7 nga tag-usa.
5. in 3 ka tagnapulo ngan 3 nga tag-usa.
6. in 0 ka tagnapulo ngan 4 nga tag-usa.
7. in 1 ka gatos, 0 ka tagnapulo ngan 0 nga tag-usa.
8. in 10 ka tagnapulo ngan 0 nga tag-usa.

B. Otro nga ihatag an balor han numero. Isurat an baton ha imo papel.

1. 56 in ____ka tagnapulo ngan ____ ka tag-usa.
2. 45 in ____ka tagnapulo ngan ____ ka tag-usa.
3. 39 in ____ka tagnapulo ngan ____ ka tag-usa.
4. 84 in ____ka tagnapulo ngan ____ ka tag-usa.
5. 97 in ____ka tagnapulo ngan ____ ka tag-usa.
6. 71 in ____ka tagnapulo ngan ____ ka tag-usa.
7. 68 in ____ka tagnapulo ngan ____ ka tag-usa.
8. 100 in ____ka tagnapulo ngan ____ ka tag-usa.

Buruhaton Pag aradman ha Balay:

A. Batona an masunod nga mga pakiana. Igsurat an imo baton ha imo **notebook**.

1. Kun mayda ka 40 nga **sticks**, pipira ka grupo hin tagnapulo an imo mahihimo? __
2. Kun mayda ka 68 nga lastiko, pipira ka grupo hin tagnapulo an imo mahihimo? __
3. Kun imo iggrugrupo an 81 nga **sticks** ha tagnapulo, pipira ka grupo an imo mahihimo?

B. Kopyaha an tsart han pwesto kantidad (**Place Value**) ha imo **notebook**. Igsurat an mga masunod nga numero ha imo pwesto kantidad nga tsart (**Place Value Chart**).

Numero	Tagnapulo	Tag-usa
47		
5		
23		
79		
64		
98		
20		
57		
60		