

## Aralin 6: Kapaligirang Inalagaan, Magandang Kinabukasan





# Pakinggan Natin





# Kilalanin Natin

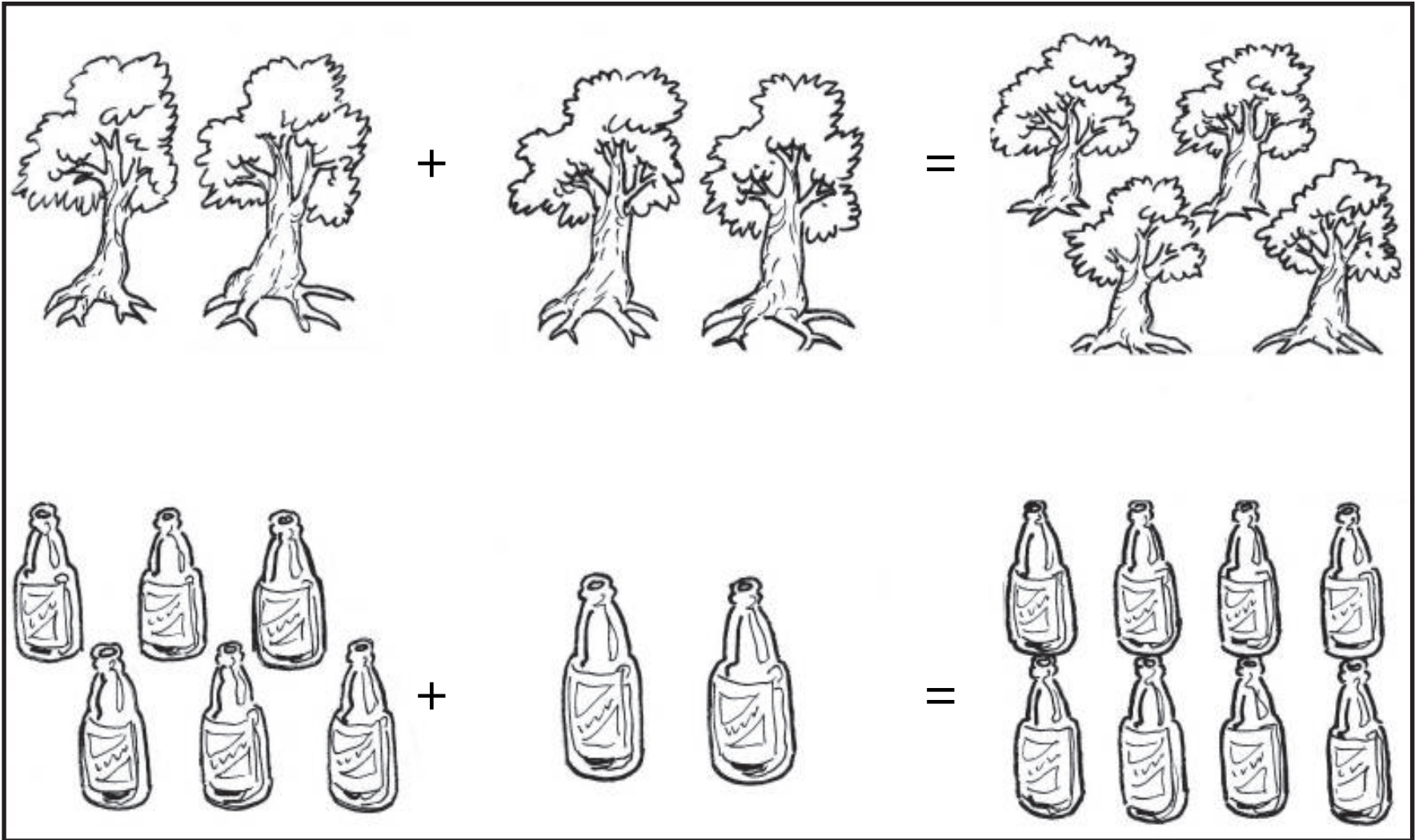

## Pag-usapan Natin

Alin sa mga kampanya at gawain ang ipinatutupad sa inyong pamayanan?

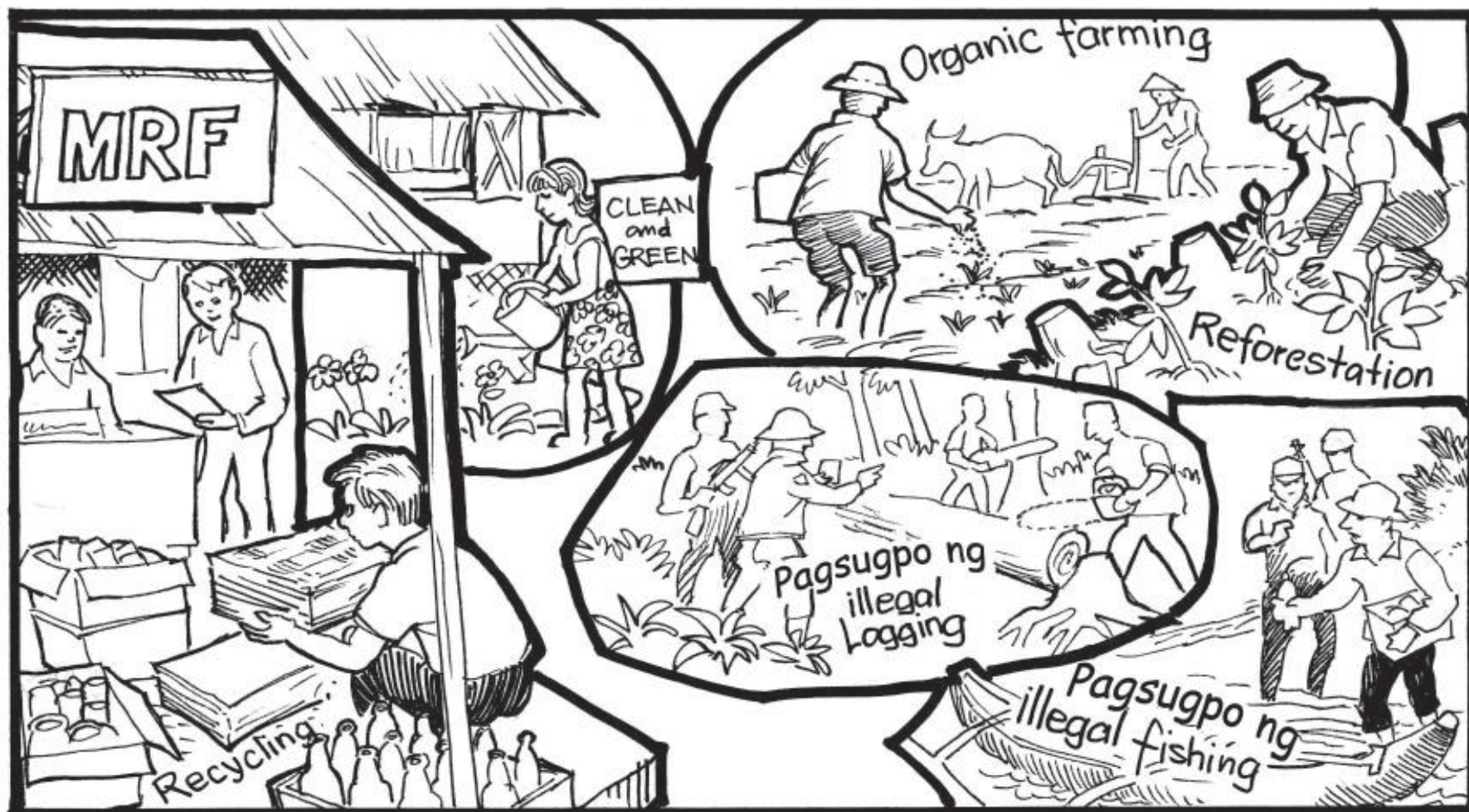



## Basahin Natin



Ang bawat barangay ay dapat magtayo  
ng *Material Recovery Facilities*.

ba ran gay

mag ta tag

b a r a n g a y

m a g t a t a g

barangay

magtatag

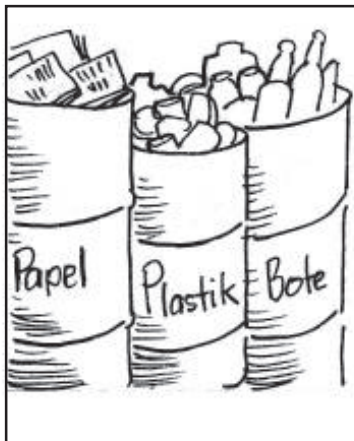

Ihiwalay ang mga basura.

i hi wa lay

ba su ra

i h i w a l a y

b a s u r a

ihiwalay

basura

Ang DENR ay nagpapatupad ng batas  
para sa kapaligiran.



nag pa pa tu pad  
n a g p a p a t u p a d  
nagpapatupad

ba tas  
b a t a s  
batas

ka pa li gi ran  
k a p a l i g i r a n  
kapaligiran



Magtanim ng puno.

mag ta nim  
m a g t a n i m  
magtanim



Ang pagtotroso ay isa sa mga sanhi  
ng pagbaha.

pag to tro so  
p a g t o t r o s o  
pagtotroso

pag ba ha  
p a g b a h a  
pagbaha



Gamitin sa halaman ang organikong  
pataba.

o r g a n i k o  
o r g a n i k o  
organiko

p a t a b a  
p a t a b a  
pataba





## Tandaan Natin

Makilahok sa sumusunod na kampanya at gawain sa pagpapaunlad ng pamayanan tulad ng:

- pagpigil sa pagkakaingin
- pag-iwas sa ilegal na pagtotroso at paggamit ng dinamita sa pangingsda
- wastong paraan ng pagtatapon ng basura
- pagtatanim ng mga puno
- paggamit ng organikong pataba

Ang DENR ay ang ahensiya ng pamahalaan na nagpapatupad ng batas para sa kapaligiran.

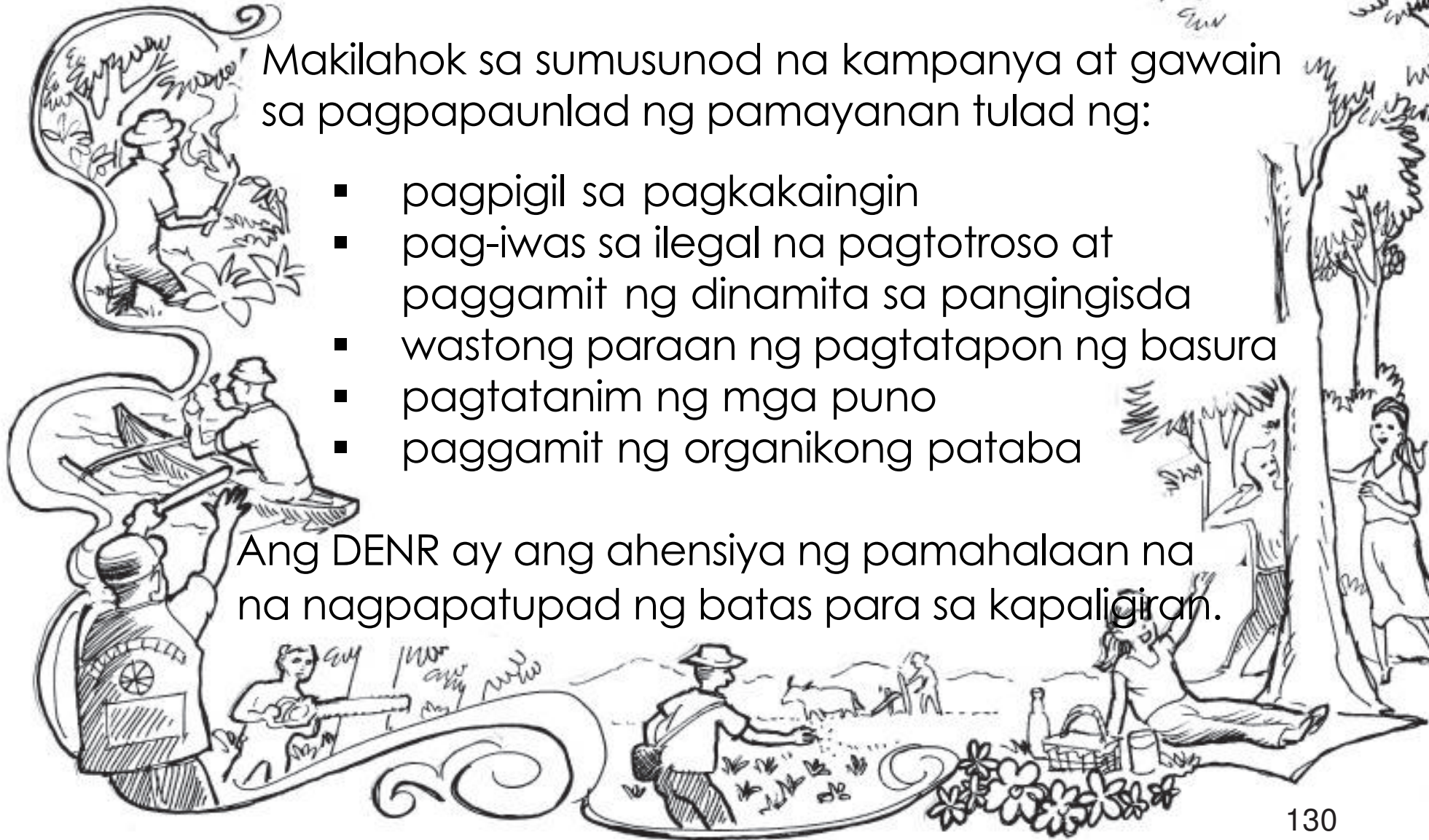



## Subukin Natin

Lagyan ng tsek (✓) ang mga gawain at kampanya na ipinatutupad sa inyong pamayanan.



Pagtatayo ng  
MRF sa barangay

Pagtatanim ng  
mga puno



Paghihiwalay ng  
mga basura

Paggamit ng  
organikong pataba  
sa halaman

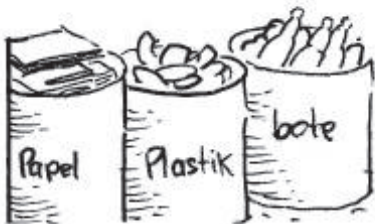



## Isulat Natin

Bakatin sa sagutang papel.

baranggay

**baranggay baranggay**

magtatag

magtatag magtatag

hiwalay

hiwalay hiwalay

batas

batas batas

nagpapatupad

nagpapatupad

nagpapatupad

basura

basura

basura

magtanim

magtanim

magtanim

kapaligiran

kapaligiran

kapaligiran

Gayahin sa sagutang papel.

baranggay

magtatag

ihawalay

basura

nagpapatupad

batas

kapaligiran

magtanim



## Subukin Natin

Isulat sa sagutang papel nang maayos at wasto ang mga salita.

1. kapaligiran

---

---

---

2. magtatag

---

---

---

3. ihiwalay

---

---

---

4. pagtotroso



5. magtanim





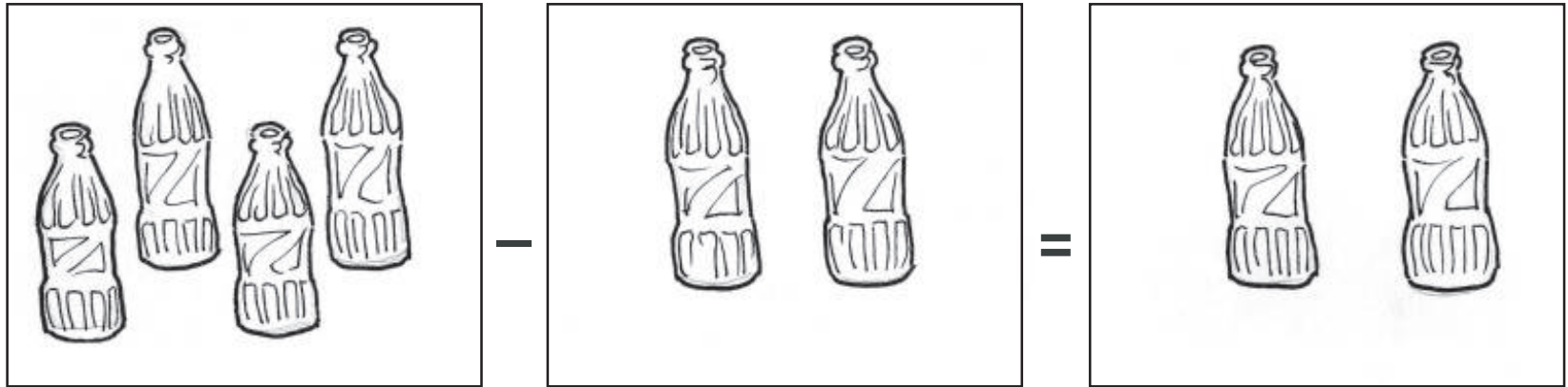

# Kwentahin Natin

Pagbabawas.

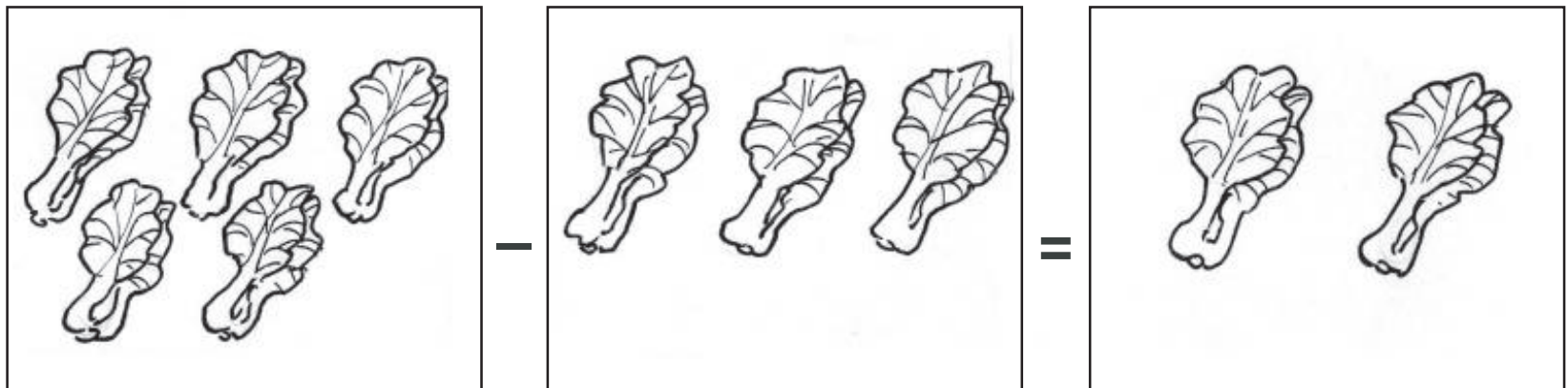

\_\_\_\_\_ - \_\_\_\_\_ = \_\_\_\_\_



\_\_\_\_\_ - \_\_\_\_\_ = \_\_\_\_\_

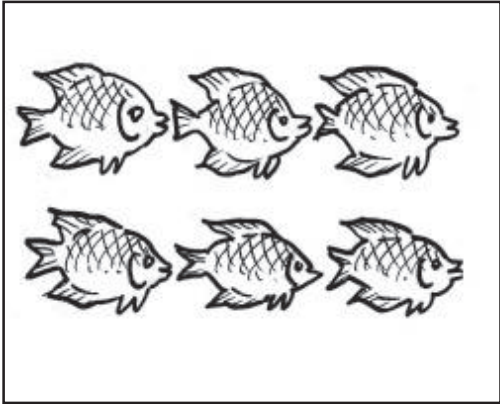

-

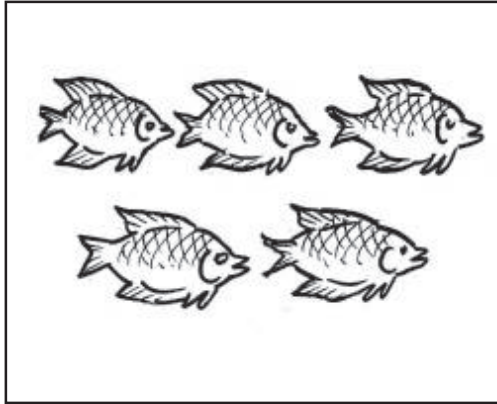

=

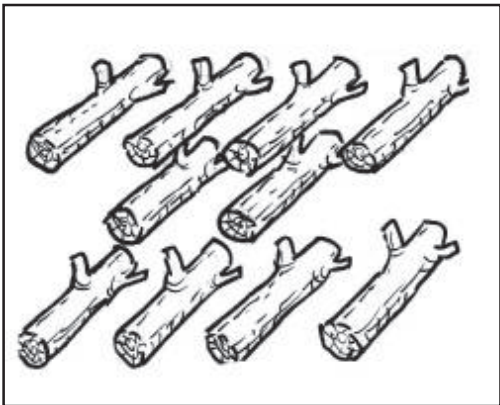
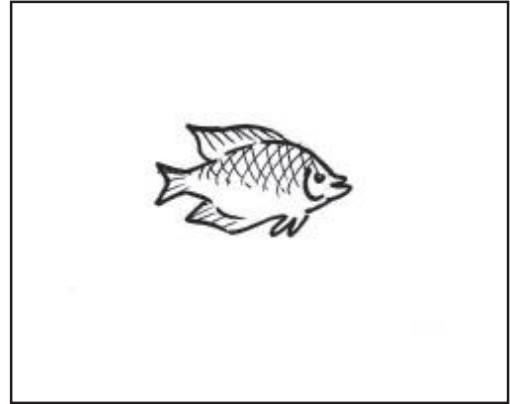

-

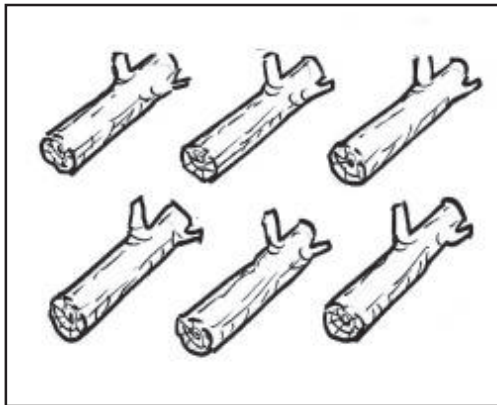

=

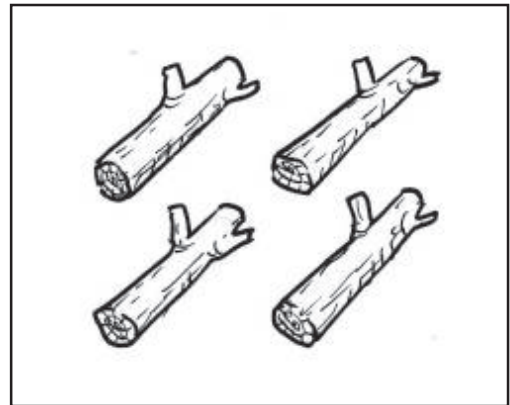

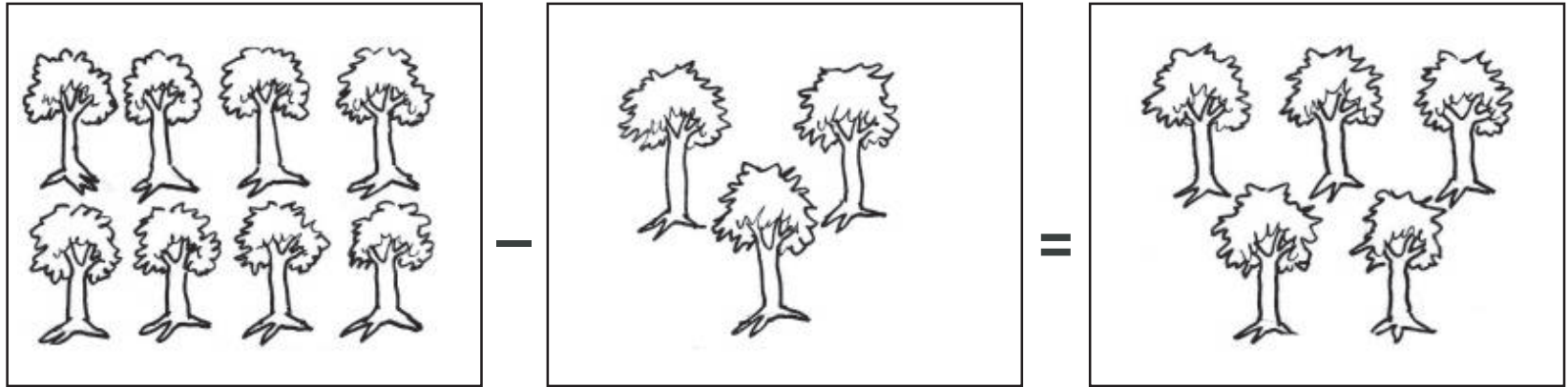

\_\_\_\_\_ - \_\_\_\_\_ = \_\_\_\_\_

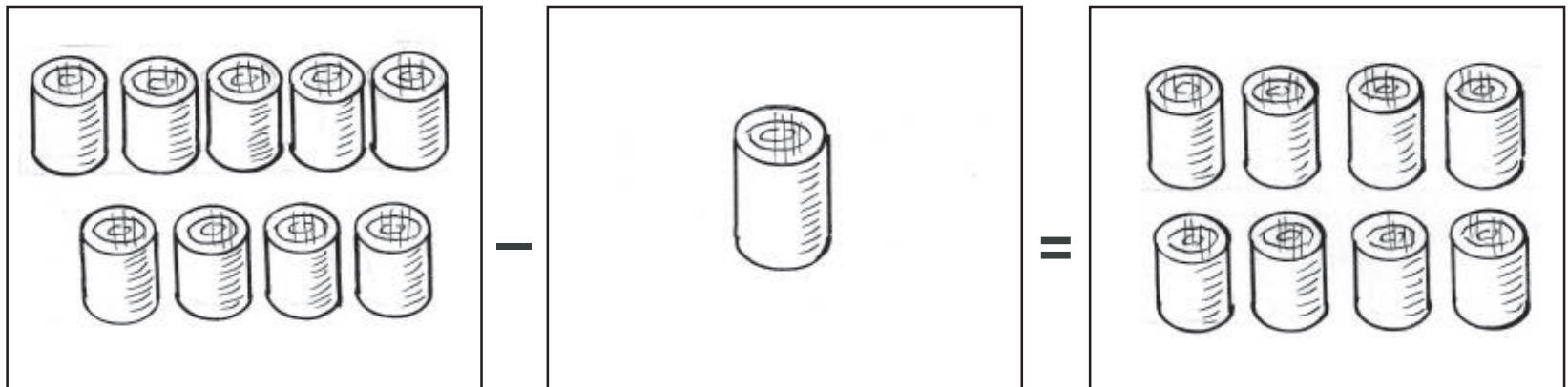

\_\_\_\_\_ - \_\_\_\_\_ = \_\_\_\_\_



# Subukin Natin

Pagbabawas. Isulat sa sagutang papel ang tamang bilang ng mga bagay sa kahon.

1.

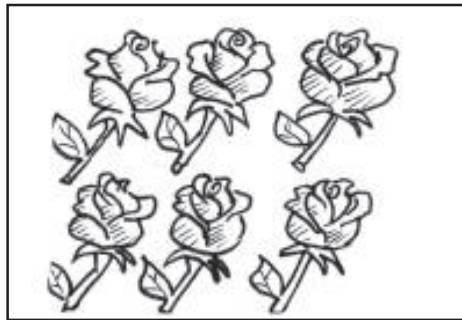

-

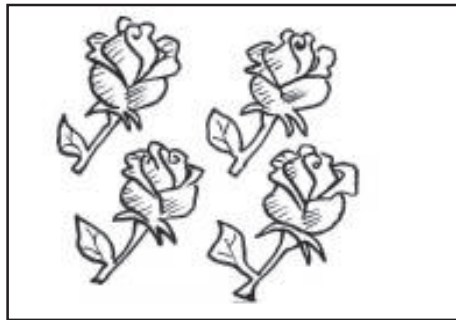

=

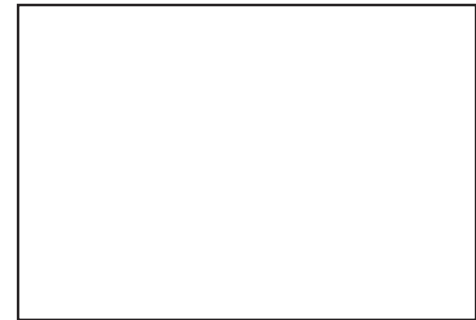

2.

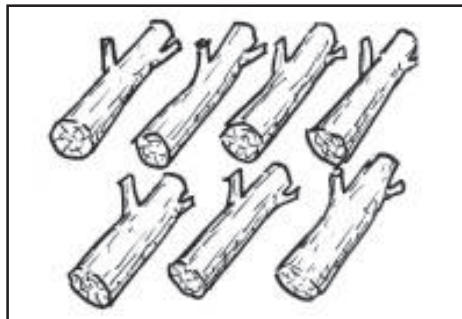

-

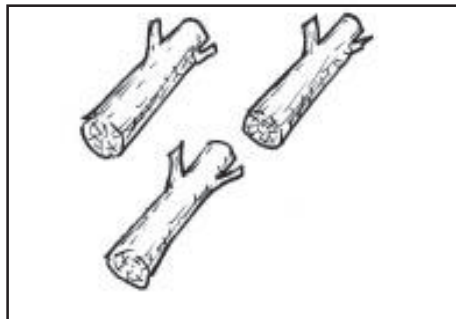

=



3.

9

-

2

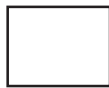

4.

6

-

3



5.

5

-

2





## Alam mo na ba?

A. Pag-ugnayin sa pamamagitan ng guhit ang larawan at ang parirala.

1.

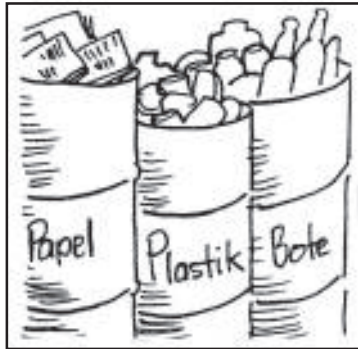

nagtatanim ng puno

2.



paghihiwalay na mga basura

3.



pagtatayo ng MRF

B. Pagbabawas. Isulat ang tamang bilang sa kahon.

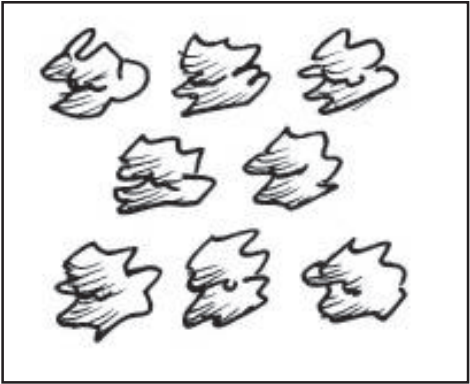
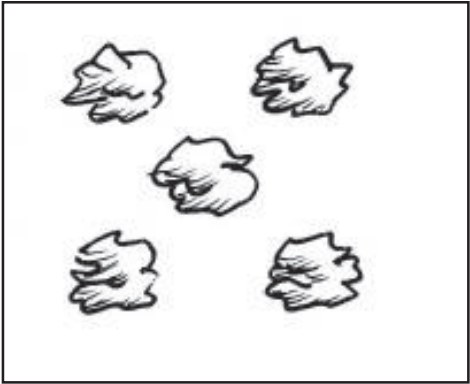
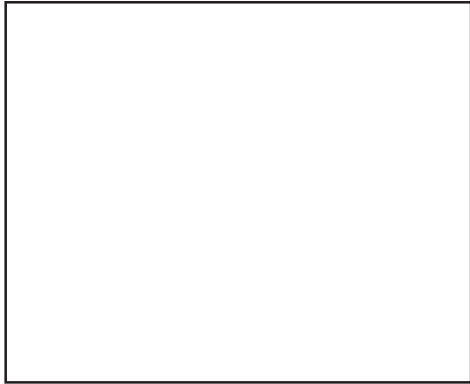
1.  -  = 

**8**                      **5**                      = \_\_\_\_\_

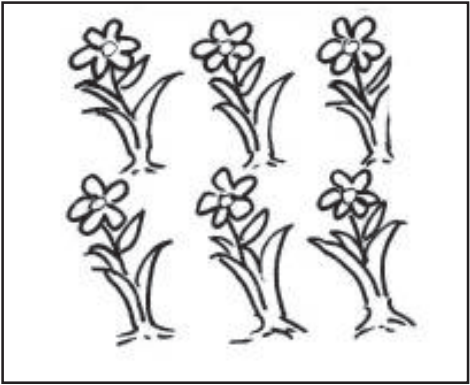
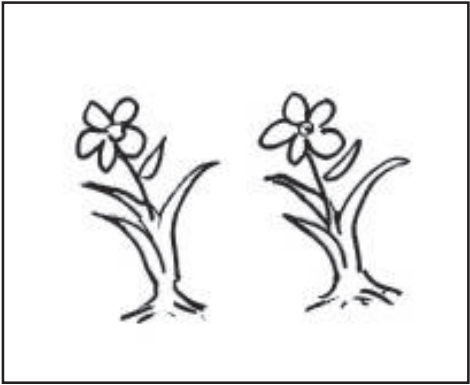
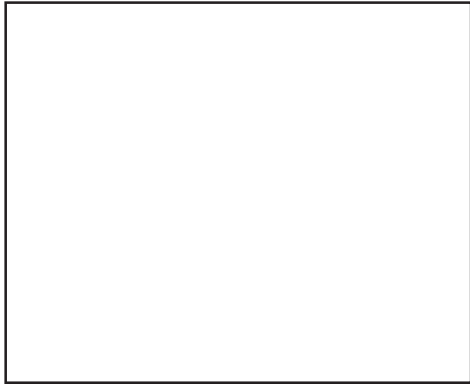
2.  -  = 

**6**                      **2**                      = \_\_\_\_\_

3.     7  
   - 5

4.     4  
   - 1

C. Bumuo ng maiksing salita mula sa mahahabang salita.

Halimbawa: magtanim – tanim, ani, mani, aga, maga, mina

1. kapaligiran

2. magtatag

3. ihiwalay

D. Isulat sa sagutang papel ang **DM** kung dapat makilahok sa kampanya at **DDM** kung di dapat makilahok.

1.

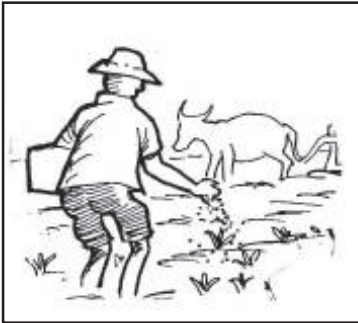

Paggamit ng organikong pataba

3.

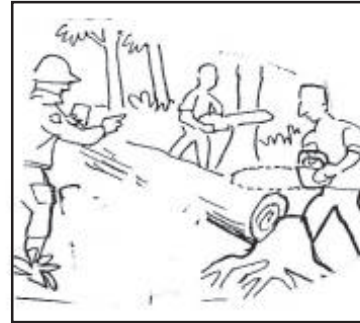

Ilegal na pagtotroso

2.

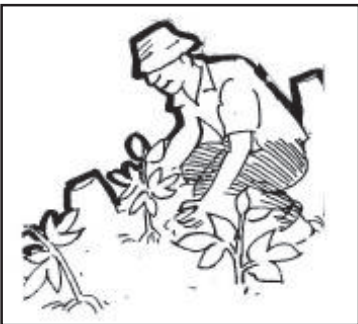

Pagtatanim ng mga puno

4.



Paggamit ng dinamita